

# x-mGC

**Part Number: FCU-022M101**



## Features

- **Compliant with IEEE802.3ak (10GBASE-CX4)**
- **X2 MSA Rev 1.0b Compatible module**
- **Industry standard electrical connector, microGiGaCN™ (I/O interface)**
- **XAUI Four channel electrical interface (Host side card edge)**
- **XAUI Standard 70 pin connector for host connection**
- **Front panel hot swap ability.**
- **X2 MSA Rev 1.0b compliant MDIO**
- **Link Alarm Status Interrupt (LASI) support**
- **Total Power consumption under 3.0 watt**
- **20 meters over standard InfiniBand copper cable (24AWG)**
- **With media detect converter (o-mGC), up to 300 meters over standard multi mode fiber.**
- **No external clocks requirement – oscillator on board**

## Description

The x-mGC is a 10Gigabit Ethernet CX4 Module that designed to ease X2 MSA Rev 1.0b and it is an electrical module that incorporates the complete physical layer functionality from XAUI compliant 4 lanes x 3.125 Gb/s four differential electrical interface to the microGiGaCN™ CX4 compliant electrical interface. The x-mGC is plugged into a X2 hosting system and connects to a 4X InfiniBand cable. The control interface (MDIO) is also integrated. The x-mGC module includes 10Gb/s Ethernet transmitter and receiver ports. The host may control the x-mGC registers using XAUI interface as defined in the X2 MSA. The MUX/DEMUX, XAUI interface and MDIO management functions are all integrated into the module, as is a precision oscillator that removes any need for an external reference clock.

**x-mGC Block Diagram**

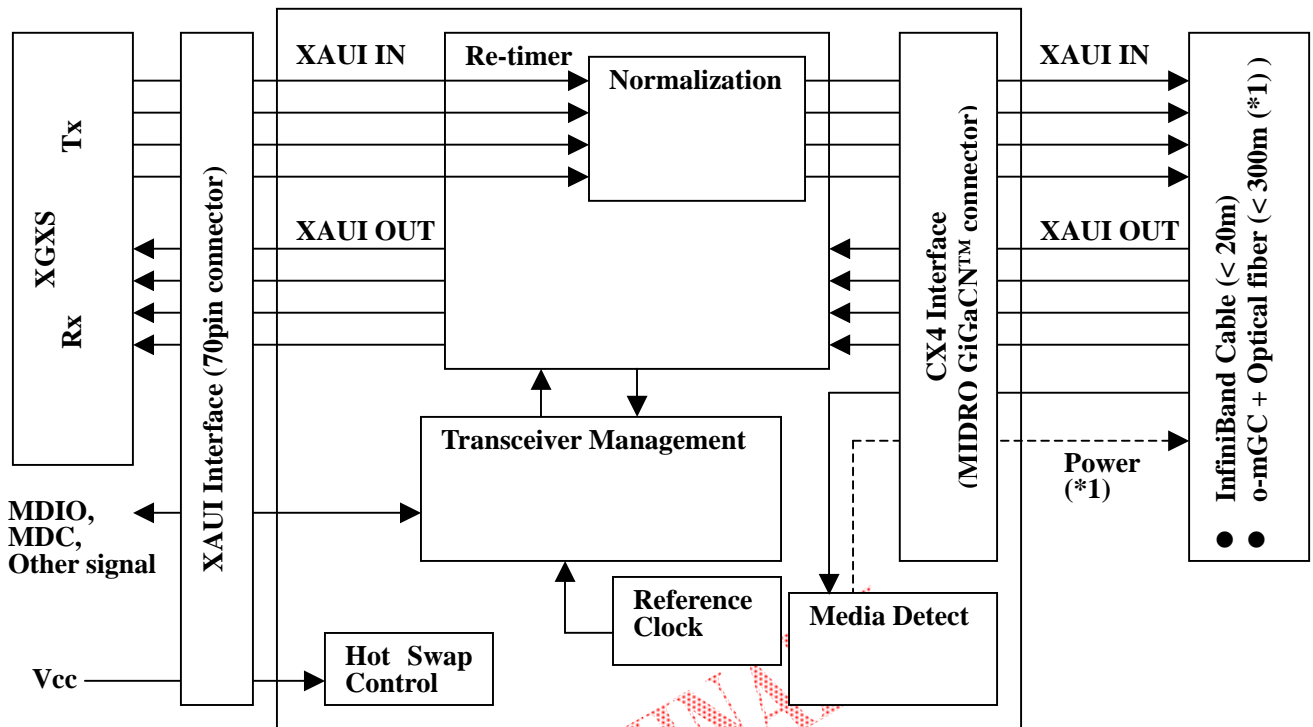

**Figure 1: Functional Block Diagram of x-mGC module**

(\*1) In case of InfiniBand cable is connected, the power does not supply to cable, and if o-mGC is connected, a ground contact is changed Vcc for power supply to o-mGC by Media detect function.

**General Electrical Specification**

- Interface: XAUI side; 70 pin SMT connector (See X2 MSA Rev1.0b, chapter 6.7)  
CX4 side; InfiniBand 4X connector (microGiGaCN™, Fujitsu Component LTD. Patent)
- Differential signal rate: Tx and Rx each 3.125 Gb/s x 4 pair
- Impedance: 100 ohms differential, AC-coupled I/O
- Adaptable Cable and Link Length: ; InfiniBand 4X cable 20m over
- Supply Voltage: 3.3V and 1.5V
- Supports standard LVCMOS 1.2V host interface.

**Environmental Specification**

- Operating case temperature: 0 - 70 degree (In an uniform air flow of 0.5 m/s.)
- Power consumption: 2.1 Watt Max

Figure 2: Top Level Block Diagram of x-mGC Driver

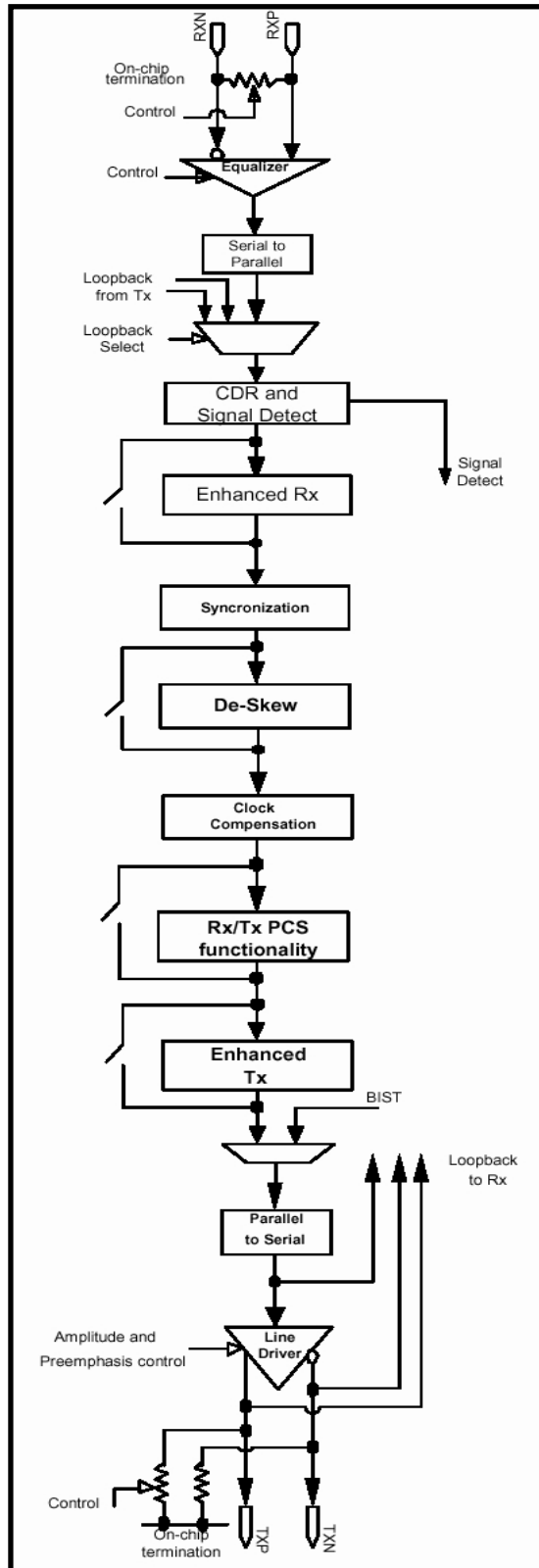

**Technical specification**

**Table 1: Transmitter characteristics**

Parameter	Typical	Units	Notes
Signal data rate	3.125	Gb/s	+/-100ppm
Unit interval (UI) nominal	320	ps	
Differential peak to peak output voltage Maximum	1200	mVp-p	
Minimum	800	mVp-p	
Differential peak to peak output voltage difference	150	mVp-p	Maximum
Differential output return loss	See figure 3	dB	Minimum
Differential output template	See figure 4	V	
Transition time (20-80%) Maximum	130	ps	
Minimum	60	ps	
Output jitter Random jitter	0.27	UIpp	
Deterministic jitter	0.17	UIpp	
Total jitter	0.35	UIpp	

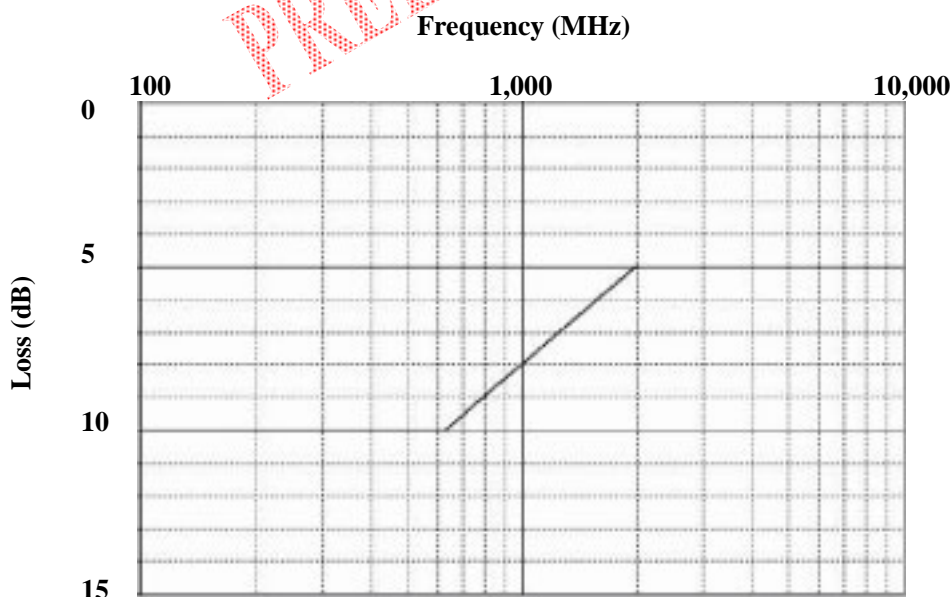

**Figure 3: Transmit differential output return loss**

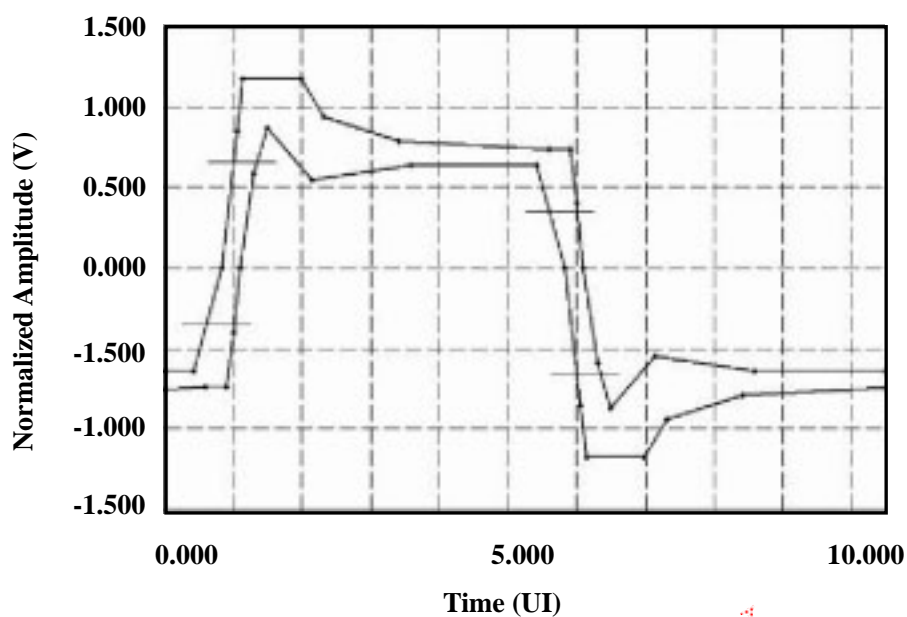

Figure 4: Normalized transmit template

Table 2: Receiver characteristics

Parameter	Typical	Units	Notes
Bit error ratio	$10^{-12}$		
Signal data rate	3.125	Gb/s	+/-100ppm
Unit interval (UI) nominal	320	ps	
Differential input amplitude	1200	mVp-p	Maximum
Return loss differential (minimum)	See figure 3	dB	100ohm

**XAUI Interface**

**Table 3: Driver characteristics**

Parameter	Typical	Units	Notes
Transmit data rate	3.125	Gb/s	+/-100ppm
Unit interval nominal	320	ps	
Differential amplitude	1600	mVp-p	Maximum
Absolute output voltage limits			
Maximum	2.3	V	
Minimum	-0.4	V	
Differential skew	15	ps	Maximum
Differential output return loss	10	dB	Minimum
Common mode output return loss	6	dB	Minimum
Eye mask	See figure 5		

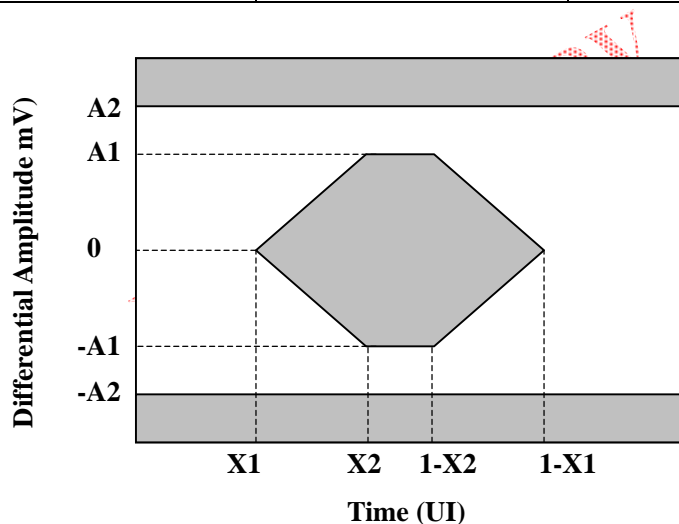

**Figure 5: Driver Template**

**Table 4: Driver Template**

Symbol	Near-End Value	Far-End Value	Units
X1	0.175	0.275	UI
X2	0.390	0.4	UI
A1	400	100	mV
A2	800	800	mV

**Table 5: Receive Input parameters**

Parameter	Typical	Units	Notes
Transmit data rate	3.125	Gb/s	+/-100ppm
Unit interval nominal	320	ps	
Differential input amplitude			
Maximum	1600	mVp-p	
Minimum	200	mVp-p	
Return loss			
Differential	10	dB	
Common	6	dB	
Input differential skew	75	ps	Maximum
Jitter amplitude tolerance			
Peak-to-peak total jitter	0.65	UIpp	
Peak-to-peak deterministic jitter	0.47	UIpp	

PRELIMINARY

**x-mGC XAUI Pin out**

70	GND	1	GND
69	GND	2	GND
68	RESERVED	3	GND
67	RESERVED	4	5.0V
66	GND	5	3.3V
65	TX LANE3-	6	3.3V
64	TX LANE3+	7	APS (1.5V)
63	GND	8	APS (1.5V)
62	TX LANE2-	9	LASI
61	TX LANE2+	10	RESET
60	GND	11	VEND SPECIFIC
59	TX LANE1-	12	TX ON/OFF
58	TX LANE1+	13	RESERVED
57	GND	14	MOD DETECT
56	TX LANE0-	15	VEND SPECIFIC
55	TX LANE0+	16	VEND SPECIFIC
54	GND	17	MDIO
53	GND	18	MDC
52	GND	19	PRTAD4
51	RX LANE3-	20	PRTAD3
50	RX LANE3+	22	PRTAD2
49	GND	21	PRTAD1
48	RX LANE2-	23	PRTAD0
47	RX LANE2+	24	VEND SPECIFIC
46	GND	25	APS SET
45	RX LANE1-	26	RESERVED
44	RX LANE1+	27	APS SENSE
43	GND	28	APS (1.5V)
42	RX LANE0-	29	APS (1.5V)
41	RX LANE0+	30	3.3V
40	GND	31	3.3V
39	RESERVED	32	5.0V
38	RESERVED	33	GND
37	GND	34	GND
36	GND	35	GND

Top of Transceiver PCB

Bottom of Transceiver PCB (as viewed through top)

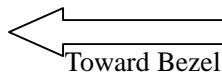

**Figure 6: x-mGC transceiver Electrical pad layout**



1	□	GND	70	□	GND
2	□	GND	69	□	GND
3	□	GND	68	□	RESERVED
4	□	5.0V	67	□	RESERVED
5	□	3.3V	66	□	GND
6	□	3.3V	65	□	TX LANE3-
7	□	APS (1.5V)	64	□	TX LANE3+
8	□	APS (1.5V)	63	□	GND
9	□	LASI	62	□	TX LANE2-
10	□	RESET	61	□	TX LANE2+
11	□	VEND SPECIFIC	60	□	GND
12	□	TX ON/OFF	59	□	TX LANE1-
13	□	RESERVED	58	□	TX LANE1+
14	□	MOD DETECT	57	□	GND
15	□	VEND SPECIFIC	56	□	TX LANE0-
16	□	VEND SPECIFIC	55	□	TX LANE0+
17	□	MDIO	54	□	GND
18	□	MDC	53	□	GND
19	□	PRTAD4	52	□	GND
20	□	PRTAD3	51	□	RX LANE3-
22	□	PRTAD2	50	□	RX LANE3+
21	□	PRTAD1	49	□	GND
23	□	PRTAD0	48	□	RX LANE2-
24	□	VEND SPECIFIC	47	□	RX LANE2+
25	□	APS SET	46	□	GND
26	□	RESERVED	45	□	RX LANE1-
27	□	APS SENSE	44	□	RX LANE1+
28	□	APS (1.5V)	43	□	GND
29	□	APS (1.5V)	42	□	RX LANE0-
30	□	3.3V	41	□	RX LANE0+
31	□	3.3V	40	□	GND
32	□	5.0V	39	□	RESERVED
33	□	GND	38	□	RESERVED
34	□	GND	37	□	GND
35	□	GND	36	□	GND

Lower Row

Upper Row

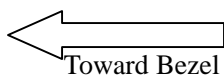

**Figure 7: 10Gb host board pad layout**

**Pin function definitions**

Pin No	Name	Dir	Function	Notes
1	GND		Electrical Ground	1
2	GND		Electrical Ground	1
3	GND		Electrical Ground	1
4	5.0V		Power	2
5	3.3V		Power	2
6	3.3V		Power	2
7	APS (1.5V)		Adaptive Power Supply	2
8	APS (1.5V)		Adaptive Power Supply	2
9	LASI		LVC MOS 1.2V Open Drain	3
10	RESET	I	LVC MOS 1.2V Open Drain	3
11	VEND SPECIFIC-signal detect		Passive	
12	TX ON/OFF			
13	RESERVED		Reserved	4
14	MOD DETECT	O	Passive	
15	VEND SPECIFIC-spare		Passive	
16	VEND SPECIFIC-spare		Passive	
17	MDIO	I/O	Management Data IO LVC MOS 1.2V Open Drain	3,4
18	MDC	I	Management Data Clock	3,4
19	PRTAD4	I	Port Address Bit 4 (Low = 0)	3
20	PRTAD3	I	Port Address Bit 3 (Low = 0)	3
21	PRTAD2	I	Port Address Bit 2 (Low = 0)	3
22	PRTAD1	I	Port Address Bit 1 (Low = 0)	3
23	PRTAD0	I	Port Address Bit 0 (Low = 0)	3
24	VEND SPECIFIC-not connected		Passive	
25	APS SET (1.5V)		Passive	
26	RESERVED		Reserved	4
27	APS SENSE		Passive Connector to a 348 ohm resistor	
28	APS (1.5V)		Adaptive Power Supply	2
29	APS (1.5V)		Adaptive Power Supply	2
30	3.3V		Power	2
31	3.3V		Power	2
32	5.0V		Power	2
33	GND		Electrical Ground	1
34	GND		Electrical Ground	1
35	GND		Electrical Ground	1

**Table 6: XAUI Pin function 1**

Pin No	Name	Dir	Function	Notes
36	GND		Electrical Ground	1
37	GND		Electrical Ground	1
38	RESERVED		Reserved	
39	RESERVED		Reserved	
40	GND		Electrical Ground	1
41	RX LANE0+		Module XAUI Output Lane 0+	5
42	RX LANE0-		Module XAUI Output Lane 0-	5
43	GND		Electrical Ground	1
44	RX LANE1+		Module XAUI Output Lane 1+	5
45	RX LANE1-		Module XAUI Output Lane 1-	5
46	GND		Electrical Ground	1
47	RX LANE2+		Module XAUI Output Lane 2+	5
48	RX LANE2-		Module XAUI Output Lane 2-	5
49	GND		Electrical Ground	1
50	RX LANE3+		Module XAUI Output Lane 3+	5
51	RX LANE3-		Module XAUI Output Lane 3-	5
52	GND		Electrical Ground	1
53	GND		Electrical Ground	1
54	GND		Electrical Ground	1
55	TX LANE0+		Module XAUI Input Lane 0+	5
56	TX LANE0-		Module XAUI Input Lane 0-	5
57	GND		Electrical Ground	1
58	TX LANE1+		Module XAUI Input Lane 1+	5
59	TX LANE1-		Module XAUI Input Lane 1-	5
60	GND		Electrical Ground	1
61	TX LANE2+		Module XAUI Input Lane 2+	5
62	TX LANE2-		Module XAUI Input Lane 2-	5
63	GND		Electrical Ground	1
64	TX LANE3+		Module XAUI Input Lane 3+	5
65	TX LANE3-		Module XAUI Input Lane 3-	5
66	GND		Electrical Ground	1
67	RESERVED		Reserved	
68	RESERVED		Reserved	
69	GND		Electrical Ground	1
70	GND		Electrical Ground	1

**Table 7: XAUI Pin function 2**

Notes:

- 1) Ground connections are common for TX and RX.
- 2) All contacts of XAUI 70 pin connector are rated at 0.5A nominal.
- 3) 1.2V CMOS compatible.
- 4) MDIO and MDC timing must comply with IEEE802.3ae, Clause 45.3
- 5) XAUI output characteristics should comply with IEEE802.3ae Clause 47.

**Package Design**

Mechanical design of x-mGC is shown as in following figure8.

It is preliminary design and subject to change without notice, please check with us for the latest design.

Datum B is physical hard stop for transceiver.  
 Datum C is inside edge of slot on transceiver.  
 Datum D is vertical center of transceiver PCB.  
 Datum E is top surface of slot on transceiver.

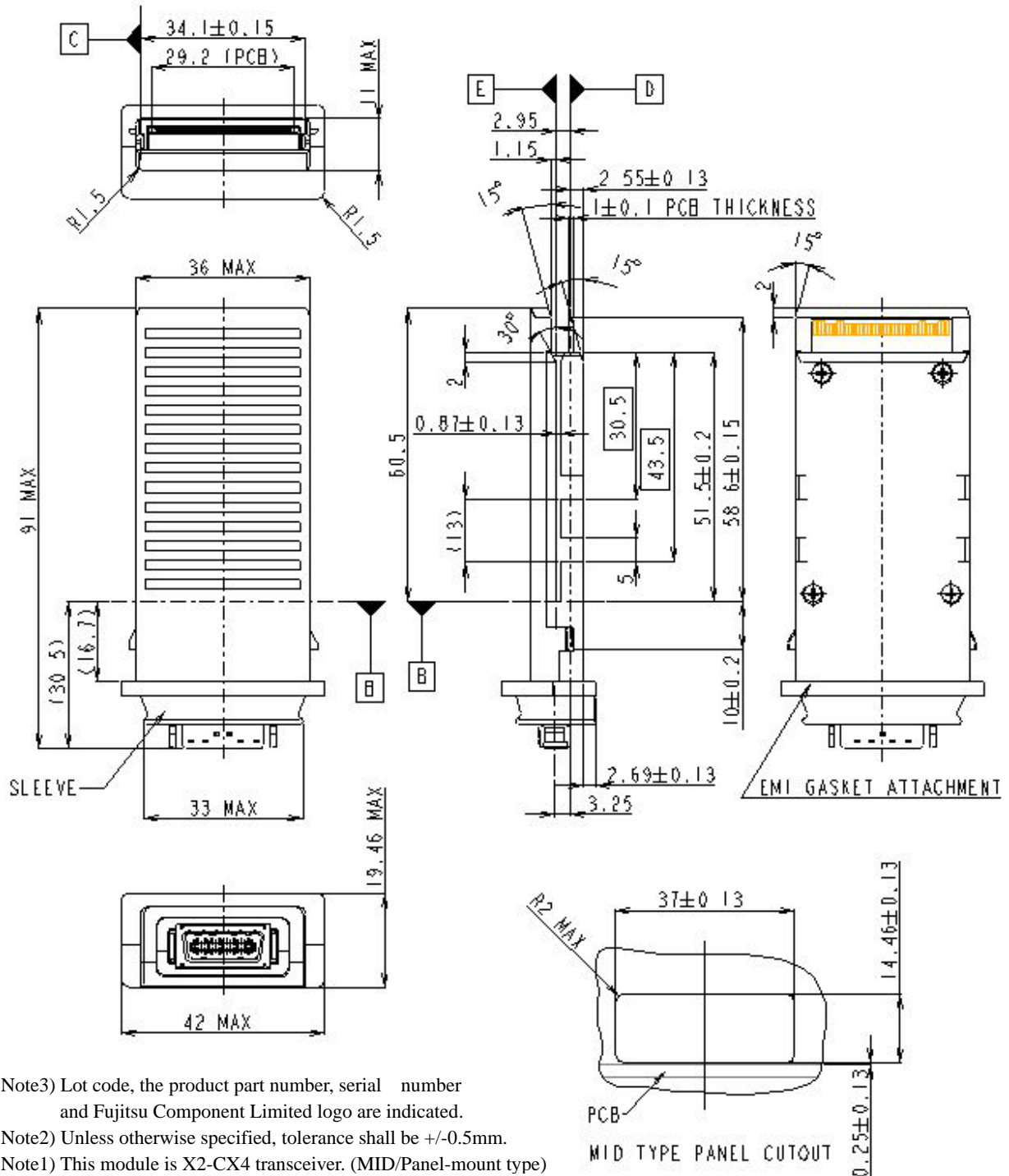

- Note3) Lot code, the product part number, serial number and Fujitsu Component Limited logo are indicated.
- Note2) Unless otherwise specified, tolerance shall be +/-0.5mm.
- Note1) This module is X2-CX4 transceiver. (MID/Panel-mount type)

**Figure 8: x-mGC schematic drawing**