

# White paper

## ANSYS® Fluent® with PRIMERGY HPC: HVAC for Built Environment



With high-performance computing construction firms and architects have the tools to design more efficient, comfortable and safer buildings by subjecting prototypes to thorough robustness simulations, including detailed analysis of smoke hazard and countermeasures.



Content	
Introduction	2
Why do we need to change a 6,000-year old recipe?	2
New challenges make the job more difficult	2
New solutions address today's complexity	2
Designing for HVAC workloads	3
Maximising parallel scalability	4
Processor types – performance versus efficiency	4
Optimal processor frequency	5
Applying HPC to production HVAC workloads	5
Capture the full behaviour with transient simulation	5
Raise quality with robust design optimisation	5
Matched reference configurations	6
Delivering the value of HPC	6
Workload-based design	6
Dynamic scale	6
Improving productivity	7
HVAC modelling capabilities	7
Conclusion	8

## Introduction

### Why do we need to change a 6,000-year old recipe?

Breathtaking landmarks were built for thousands of years without any computers. But the situation has changed dramatically in terms of competition, regulations and environment. In today's world, engineers and architects increasingly employ engineering simulation to enable the design of atria, auditoriums, buildings, stadiums and sports arenas to meet energy-efficiency and sustainability goals within strict project timelines. Engineering simulation software is used to create a virtual prototype of a building or interior space on a computer, and calculate the heating, cooling and ventilation performance or model any disaster it might experience during its life time to ensure a perfect building integrity. This virtual building design approach leads to the rapid investigation of alternative designs and a better understanding of the design elements that can improve building performance, and allows the design team to more easily explore innovative solutions while reducing their exposure to risk.

Engineering simulation helps architects and engineers determine the best designs for heating and air conditioning equipment, to analyze the performance of smoke management systems in the event of a fire and to ensure that the occupants are exposed to a desired level of thermal and moisture comfort. Building ventilation system designs that deliver indoor air quality, thermal comfort and energy efficiency can be better achieved through virtual building design.

### New challenges make the job more difficult

With the tightening of safety and environmental regulations combined with global competition, the design of new structures is reaching new levels of complexity.

## Heating, ventilation and air conditioning (HVAC) new challenges

### ■ Environment

Recent environmental regulations and concerns are further constraining the construction of any new edifice. These regulations aim to minimize the environmental footprint by reducing the energy needed to maintain comfortable temperature and humidity levels. Annoyances for the neighbourhood, such as projected shade on existing buildings and wind induced at the pedestrian level, are also increasingly regulated.

### ■ Competition

While the new construction will essentially be done locally, its design can be made anywhere. Global competition is fierce to win projects that could be worth millions of dollars; saving cost or time on bids could make a difference. The solution might come from using unconventional, sometimes unpredictable technologies and materials outside the experience of many practicing engineers and architects.

### ■ Safety and security

Across the world, regulations are multiplying to ensure the long-term safety of any building. Before construction starts, the designer must demonstrate that the edifice will sustain any major and possibly extreme natural disasters, such as major earthquake, flood, hurricane or accident (such as fire, traffic impact, etc.). In many cases, security issues to prevent terrorist attacks are raised in a project's early stage.

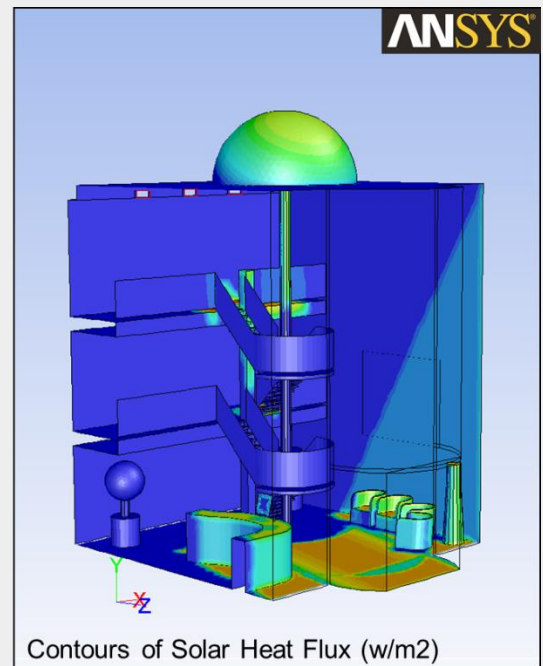

Image courtesy of ANSYS Inc.

### New solutions address today's complexity

An increasing number of companies are adopting engineering simulation in order to predict, see and adjust how a given edifice will behave under service and extreme conditions. And this is precisely where HPC simulation with ANSYS Fluent helps to address these challenges in the construction industry.

Experimental work has been done for centuries and will still be done in parallel with simulation in a verification and validation spirit. However, the popularity of virtual modeling is growing fast:

### ■ Cost of prototypes

In the construction industry, full-scale prototypes are not possible nor do they make sense. Smaller-scale prototypes are often used during the project phase. But the time and cost to build them dramatically reduces their use. Furthermore, some phenomena such as airflow doesn't scale well: reducing the flow section may change the airflow pattern from turbulent to laminar, preventing extrapolation of the observations. Comprehensive computer-based models can be time consuming to set up. Once the virtual model is developed, any additional investigation is nearly cost free and quasi immediate. Some experiments (such as a major earthquake, the worst hurricane of the century, tsunami) are nearly impossible to create.

■ Access to data and information

The devil is in the details, which are much more difficult to observe especially if you aren't paying close attention to the right place at the critical moment. Working with a digital model enables the designer to investigate any detail of the structure, as output data is available anywhere at any time step. Modern post-processing technology facilitates the immediate identification of a critical or unacceptable condition, which then captures engineers' and architects' attention only where it matters.

■ Flexibility

Modifications to prototypes are usually necessary to comply with existing or new regulations; opportunities to optimize operating cost might appear throughout the design process; authorities or neighbors might complain about the impact of a new edifice and require adjustment. The flexibility brought by a computer-based model enables parametric analysis for robust design by making Design of experiment (DOE) a standard. The process leads to much better solutions that are acceptable by all stakeholders.

■ Communication

Engineering simulation makes it easier to communicate the advantages of a given project, which is essential to win the bid. It also makes it easier to explain to detractors why the proposal minimizes any annoyance or why some modifications fully address any objection.

**Designing for HVAC workloads**

The built environment industry needs to address a very broad range of designs, from apartments to stadia and airports. And the size of the model will vary accordingly, with anything from less than 1 million to more than 100 million cells being used today. Yet across all scales, there is inherent consistency in the physics and conditions that represents the simulation of heating, ventilation and air conditioning (HVAC):

- Enclosed spaces with inflow and outflow
- Fluid motion generated by heated/cooled air and fan circulation
- Outside temperature variation from the sun's movement
- Transport and channelling of smoke and other pollutants

ANSYS and Fujitsu have partnered to study the particular characteristics of HVAC workloads and define a set of HPC systems tuned for construction industry purposes. The baseline simulation studied the transient behaviour of the air within a building to optimise for some of the main criteria that concern architects and constructors today:

- Position and regulation of radiators and fans to maintain comfortable temperature and noise within the occupied space
- Choice of window units and insulating material to optimise cost and conformance
- Smoke propagation and dispersion as well as necessary safety countermeasures

**8 million cell HVAC model with transient analysis**

**Model setup**

The basis of this study was an HVAC model representative of current production needs, with a geometry based on a large meeting room or office floorplan. Radiators and fans are placed within the building, and a variable external load was applied.

**Mesh**

- Cells: 7,897,612    Nodes: 9,679,421

**Physics**

- Transient simulation with explicit timestepping for 12 hours
- Full solar load model

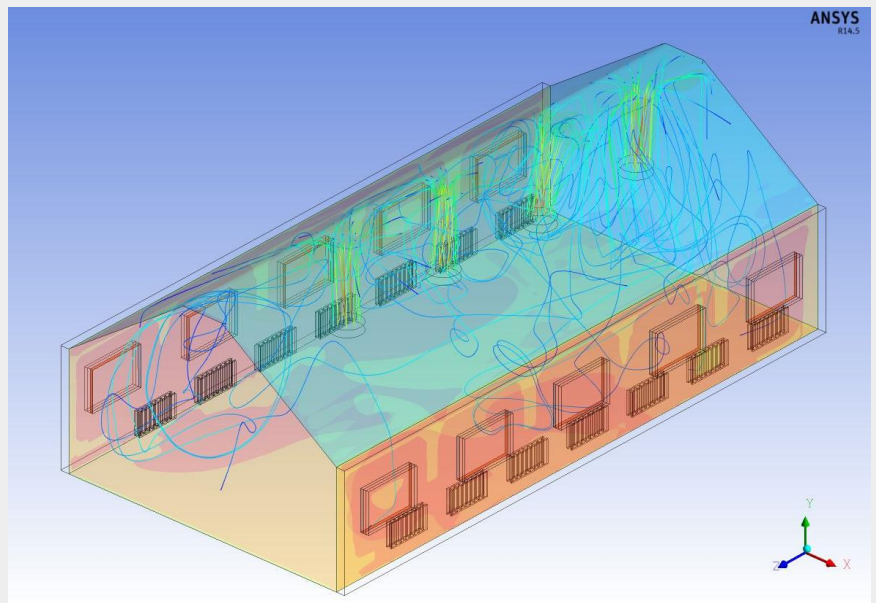



The HPC system evaluated in this study was the Fujitsu PRIMERGY CX400, comprising CX250 nodes equipped with dual Intel® Xeon® CPU processors. Comparisons were made with different processor types — varying frequency and core count — and interconnect. Parallelism was implemented with Platform MPI libraries.

Evaluation systems		
Node type	PRIMERGY CX250	PRIMERGY CX250
Processors per node	2	2
Processor type and frequency	E5-2690 v2 @ 3.00 GHz E5-2680 v2 @ 2.80 GHz E5-2670 v2 @ 2.50 GHz E5-2660 v2 @ 2.20 GHz	E5-2697 v2 @ 2.70 GHz E5-2695 v2 @ 2.40 GHz
Cores per processor	10	12
Interconnect	Infiniband Gigabit Ethernet	Infiniband Gigabit Ethernet

### Maximising parallel scalability

Running a single computation in parallel across multiple compute nodes is one of the defining characteristics of an HPC workload. More than one node becomes necessary when the turnaround time is so long that it prevents simulation of a given model within a reasonable project timeframe. There can be multiple networks that interconnect the nodes within one HPC cluster:

- A **user network** between all servers and compute nodes; uses Gigabit Ethernet technology
- A dedicated **high-speed network** to increase speed of applications when the cluster size increases; based on InfiniBand technology for low-latency, high-bandwidth for interprocess-communication between compute nodes, and sometimes for fast I/O to storage systems
- A dedicated optional network for **cluster management**; on small configurations these actions can share the user network

Measurements of Fluent on the HVAC model demonstrated that an Infiniband® interconnect is required to continue reducing elapsed time as more nodes are used in a single parallel computation. For this HVAC model with 8 million cells, the Fluent application demonstrates high efficiency up to 8 nodes with the 10-core processor (160 cores in total). The parallel efficiency is projected to remain high for even larger clusters.

In comparison, the scalability is much lower when just using Gigabit Ethernet, eventually leading to longer elapsed times and ineffective license utilisation for higher node counts.

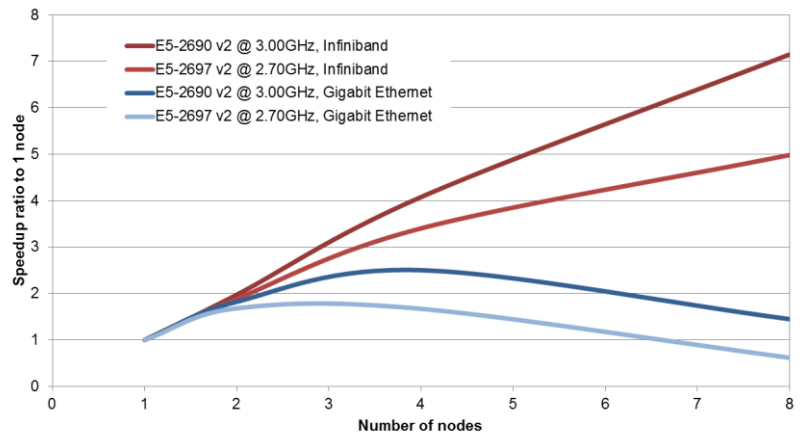

### Processor types – performance versus efficiency

The choice of which processor type to use is a balance between various factors. We start with cores per job, since this is generally controlled by the number of application licenses. Conventionally, each ANSYS Fluent computation is parallelised so that all compute nodes used for the same job are fully occupied by the processes of that application execution. With today's multi-core processors, other scheduling policies are feasible in operation.

Across different core counts per job, the aggregate trend is for 12-core processors to deliver slightly lower throughput than 10-core processors. Within the test range, the only direct common factor is 120 cores. At this point, 5 nodes of the 2.7 GHz 12-core processor are around 20 percent slower than 6 nodes of the 2.8 GHz 10-core processor for this HVAC model. One less node clearly reduces the overall node cost. However, the baseline 12-core price is higher than 10-core, so that Intel Xeon CPU E5-2690 v2 nodes deliver the optimal price-performance for HVAC workloads.

A further alternative is the E5-2650 v2 processor, with 8 cores and frequency of 2.60 GHz. Core for core, this node gives similar performance to the 10-core 2.5GHz processor.

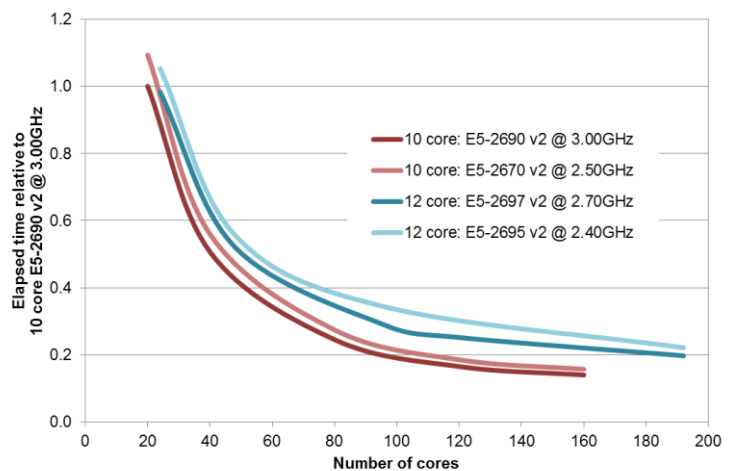

### Optimal processor frequency

Evidently, the faster processor is expected to compute in the shortest elapsed time; but frequency is not the only factor. The computational algorithm within the application can depend more on other hardware components within the node. Memory bandwidth is in many cases more significant. Higher-frequency processors are often exponentially more costly than others in the same generation.

In studying the HVAC model, we compared in turn the 2.8 GHz, 2.5 GHz and 2.2 GHz to the reference 3.0 GHz performance. If frequency were the only factor, then we would expect the ratio of elapsed times to equal the clock (inverse frequency) ratio. Instead, the ratio is actually less; although throughput is less, they are relatively more efficient than the 3.0 GHz processor. When price is factored, the 2.5 GHz processor gives the optimal balance with an acceptable maximum throughput only 10 percent less than the more costly 3.0 GHz CPU.

Still, if absolute speed is the requirement, then the 3.0 GHz processor remains the better option. Moreover, when application license cost is factored, then the hardware cost for higher frequency CPUs becomes relatively lower.

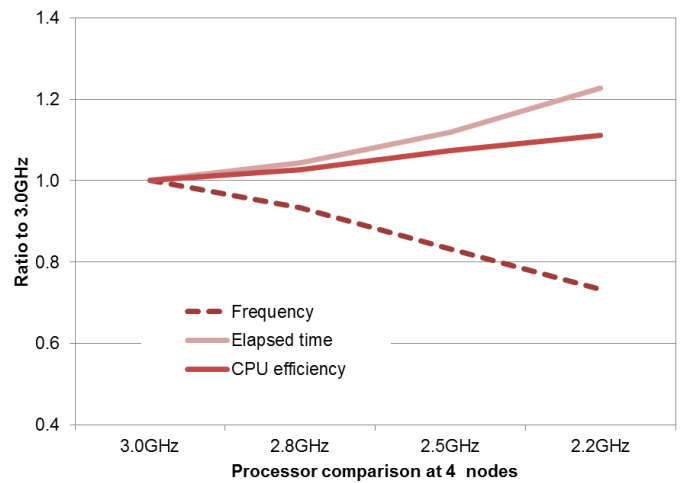

### Applying HPC to production HVAC workloads

#### Capture the full behaviour with transient simulation

Transient simulations reveal the detailed response of the construction under changing conditions. One study may indicate how the interior environment responds to the changing position of the sun or wind gusts. Another more critical use of transient simulation is to study the propagation of smoke and fire, ensuring that designs are safer and conform to regulations to ensure proper evacuation of inhabitants. The transient simulation model in this study was initialized with a time step of 6 seconds, i.e. 7,200 steps for a 12-hour day. At the start of the computation, where the fluid variation is rapid, this could be much shorter. For other periods, the time step might be lengthened. With the objectives defined earlier, a single model run on the E5-2670 v2 processors at 2.50 GHz would take 35 hours of continuous computation across 8 nodes (160 cores) in parallel for a fine mesh with close to 8 million cells.

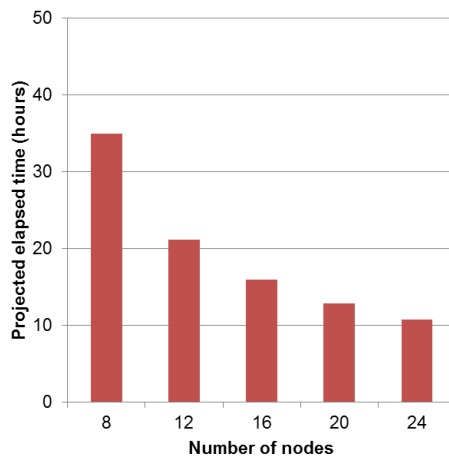
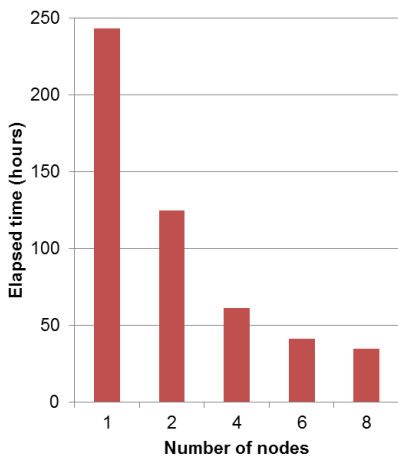

With multiple design changes and options to consider, even this level of scaling limits the turnaround that can be achieved within one week of engineering without compromising mesh quality. Scaling ANSYS Fluent across a larger cluster can further reduce the elapsed time. In the best case, a 24-node cluster could bring the turnaround below 12 hours. In practice, this is likely to be longer due to growing parallel inefficiencies, mainly as compute time for smaller model subdomains reduces compared to communication overhead. But even if the scaling efficiency drops to 60 percent, the turnaround time is still under 15 hours.

#### Raise quality with robust design optimisation

Having established the central model, based on steady-state and transient criteria, designers and engineers then begin to look at a series of optimisation phases. A first phase may use a design of experiment approach to automate the sweep across design variables for the steady state. This phase may be intended primarily to determine the ideal balance between material cost and performance. Then, ideally, a robust design study would assess the stability of the optimised solution to the external boundary conditions. Transient simulation would then be performed to understand the complete response of the construction to a complete operational environment. DOE would finally be applied to the transient case to further tune the design. Such optimising methods regularly generate tens to hundreds of further computational jobs for a given design.

**Matched reference configurations**

Different types of projects have differing simulation needs. Designing an HVAC solution for a house or small office space may represent a simulation project that takes just a few weeks. At the other end of the scale, projects for sports stadia and airports extend to many months and years. The companies that service these projects range from small/medium architect bureaus up to multi-national construction firms. From measurements on our HVAC reference model, we define matched HPC cluster systems for a normal HPC workload in common production scenarios.

**HVAC workloads for different types of construction**

Construction type	Private house	Shopping center	Stadium
Overall project duration	2 weeks	3 months	18 months
Model size (number of cells)	4 million	15 million	60 million
<b>Ideal simulation phases</b>			
	<b>Effective number of jobs</b>		
Problem setup (steady state)	10	15	25
Design of experiment (steady state)	80	150	200
Optimisation	20	50	100
Robust design optimization (RDO), steady state	20	30	40
Transient scenarios	5	10	15
DoE (transient)	15	50	100
<b>Estimated ideal project workload</b>	<b>150</b>	<b>305</b>	<b>480</b>
<b>Estimated total computational time</b>			
Hours on a single node	2,335	27,780	137,800
Months on a single node	3	39	191
Tuned cluster size - number of compute nodes	8	24	56
<b>Total elapsed hours</b>	<b>294</b>	<b>1,158</b>	<b>2,461</b>
	<b>0.4 months</b>	<b>1.6 months</b>	<b>3.4 months</b>

**Delivering the value of HPC**

**Workload-based design**

Fujitsu sector-designed PRIMERGY systems for the construction industry are shaped around production workloads. For HVAC applications using ANSYS Fluent, the Fujitsu PRIMERGY HPC cluster reference configurations deliver:

- HPC cluster components selected for optimal price-performance against sector workload, validated with direct application measurement and real models from the built environment.
- Integrated HPC architecture uniting hardware, system software and user-ready middleware: lowers acquisition risk and reduces upfront effort
- Factory-installed user environment for immediate project readiness and fast-start application usage

This sector-designed approach fully leverages expertise from low-level system tuning up to knowledge in the business layer. Benchmarking compares actual models on the widest range of system combinations to identify those most adapted to built environment sector needs, and considers how the user drives multiple jobs within an overall project. Given the large number of system combinations available today (processor type, memory, frequency, interconnect, storage), this workload-based philosophy gives confidence that the baseline system is matched to the purpose, backed with directly related expertise.

**Dynamic scale**

Systems optimised for HVAC applications can be balanced against the expected workload. Adjustments to the baseline can be made before installation, and later during operations as the workload increases. Administration effort of adding nodes to the cluster is minimised through the graphical management desktop interface that displays an integrated view of the complete cluster. The built-in HPC Gateway interface with its application workflows means cluster dynamic changes have no impact on business end-use methods, maintaining continuity and minimising disruption.

## Improving productivity

Productivity is constantly eroded by users spending more time dealing with IT than designing — writing and constantly changing script, locating misplaced data, rerunning jobs that failed during initialisation. These issues are not solved just by providing a graphical interface for which the user still enters command lines and script extracts. Real customer value is when expertise in this application-IT layer is fully embedded in the HPC environment, so designers and engineers work with a true business tool. HPC Gateway web environment inside the Fujitsu PRIMERGY system addresses this productivity area.

## HPC Gateway – Industrialising Expertise

### Running ANSYS Fluent in HPC Gateway

HPC Gateway provides a means to **industrialise expertise** in HPC usage, by capturing proven methods that can be transferred and utilised by a broad spectrum of users. Its web interface simplifies HPC cluster access from any client device. Workflow technology is used to encode the optimal application methods. With the ANSYS Fluent foundation workflow in the HPC Gateway, users are provided with the interface to set up, submit and monitor work on the HPC cluster.

Download this workflow from the Fujitsu Gateway Application Catalogue web site and self-import into the local Gateway, and within the first hours of operation, end-users can be running production work.

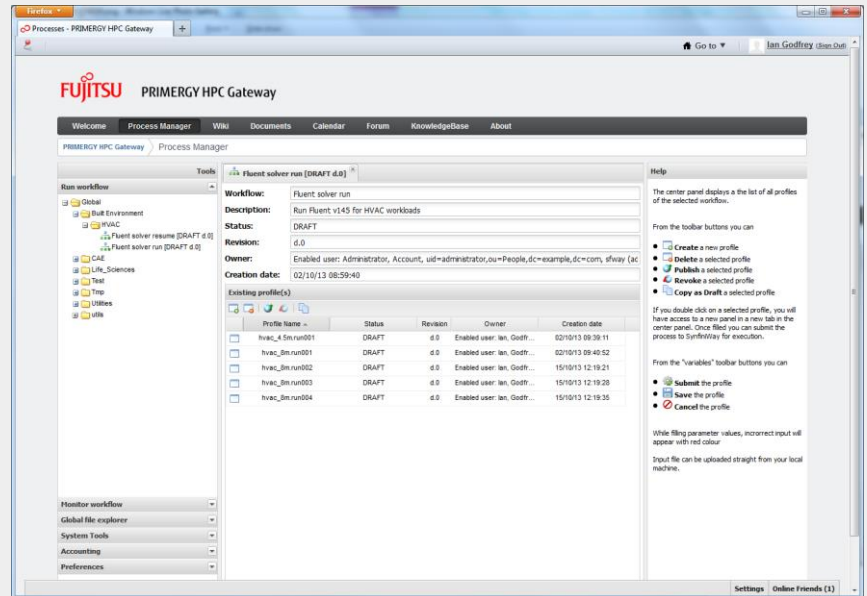

HPC Gateway provides many other benefits for both individuals and teams. Traceability is enhanced through the workflow profile table, which stores input settings for each job. Dynamic monitoring allows the user to follow application progress and control the job. Project leaders can observe all HPC activity within the project.

For HVAC requirements in the built environment industry, further workflows can be considered to capture and industrialise other expertise. For example, during a full transient study the user may want to run at an initial time step setting, assess the results, then continue the simulation with a different time step setting as input. An extended workflow to enable this and other processes can be provided through the Gateway Application Catalogue for download and import. Equally, with HCS Advanced Edition users can develop their own workflows around the foundation service to encode and automate the HPC processes that form the unique competence of the organisation. Workflow automation and expertise transfer, through the HPC Gateway, raise both individual and team productivity, from first login and for the lifecycle of the HPC system.

### HVAC modelling capabilities

Fluent provides the full range of physical models that engineers need for modeling HVAC systems and components. Using building geometry, vent locations, and fan performance curves, Fluent can predict the distribution of air velocity and temperature in room air flows. Buoyancy of heated gases and solar irradiation effects can be included. Plumes of hot gas and smoke from fires can be predicted in order to assist in safety analysis. Engineers can model steady flow or transient phenomena such as flow instabilities. Heat transfer modes include natural convection, forced or mixed convection, conduction, and radiation. For industrial workplaces, mass transfer and species mixing or reaction can be included. Fluent predicts contaminant concentration levels throughout the work area and captures efficiencies generated by alternate ventilation designs. Fluent also provides the input controls you need at model boundaries, from handling periodic conditions in heat exchangers to including profiles determined from upstream models. HVAC engineers don't need a Ph.D. in CFD to succeed with Fluent. The user interface works with them, interactively, from problem setup to solution to analysis of results. This interactive design contributes to their productivity and minimizes the possibility of errors.

## Conclusion

A workload-based approach to system design clearly reveals the benefits of high-performance computing (HPC) for heating, ventilation and air-conditioning (HVAC) simulation. In this joint study ANSYS and Fujitsu have architected a set of optimised integrated HPC clusters through direct study of an HVAC model derived from current production, with the aim of assisting both new and existing HPC users. This comprehensive review illustrates that today it is possible to lead in-depth investigation of any new building, including robust design optimisation for steady-state and transient cases in a time frame compatible with the length of the project.

An expansion of capacity to handle unsteady simulation will provide more accurate information on transient fluid behaviour. This is essential when studying fire and smoke propagation, to design countermeasures and validate against defined safety regulations. For businesses familiar with HPC the systems outlined here will ease selection of the baseline components. And with workflow automation through the HPC Gateway Advanced Edition, these organisations can codify their established methods and best practise, and expand access to a broader range of teams and projects.

Organisations new to HPC, possibly looking to increase model resolution or add a robust design capability, will gain from the validation of application efficiency and the pre-installed system environment. But more significantly, with the integrated HPC Gateway web environment, the entry point to HPC is lowered. Prebuilt application workflows can be imported into the local HPC Gateway installation, allowing end users to launch and monitor standardised methods, reducing risk and ensuring productivity from first login.

---

**Contact**  
FUJITSU TECHNOLOGY SOLUTIONS LTD

Website: [www.fujitsu.com/fts/hpc](http://www.fujitsu.com/fts/hpc)  
2013-10-01 EMEA EN

© Copyright 2013 Fujitsu, the Fujitsu logo and PRIMERGY are trademarks or registered trademarks of Fujitsu Limited in Japan and other countries. Other company, product and service names may be trademarks or registered trademarks of their respective owners. Technical data subject to modification and delivery subject to availability. Any liability that the data and illustrations are complete, actual or correct is excluded. Designations may be trademarks and/or copyrights of the respective manufacturer, the use of which by third parties for their own purposes may infringe the rights of such owner. ANSYS and any and all ANSYS, Inc. brand, product, service and feature names, logos and slogans are registered trademarks or trademarks of ANSYS, Inc. or its subsidiaries in the United States or other countries.