

SPARC Enterprise M5000 Server Unpacking Guide 開梱の手引き

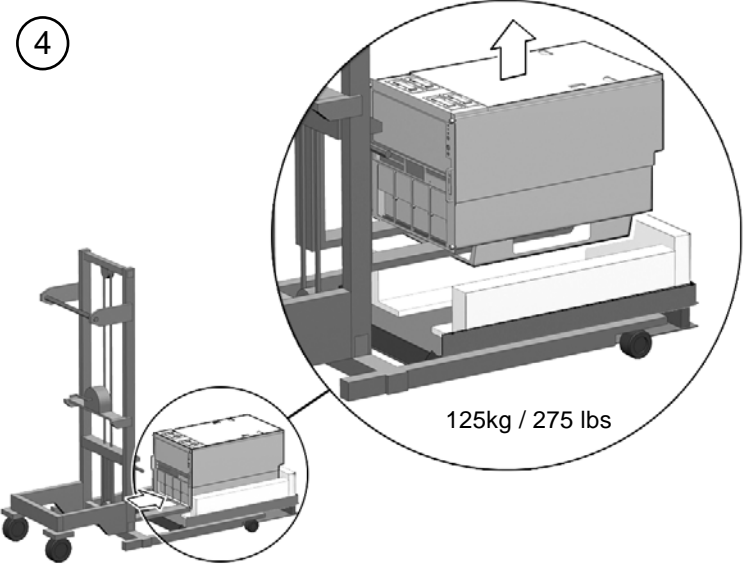
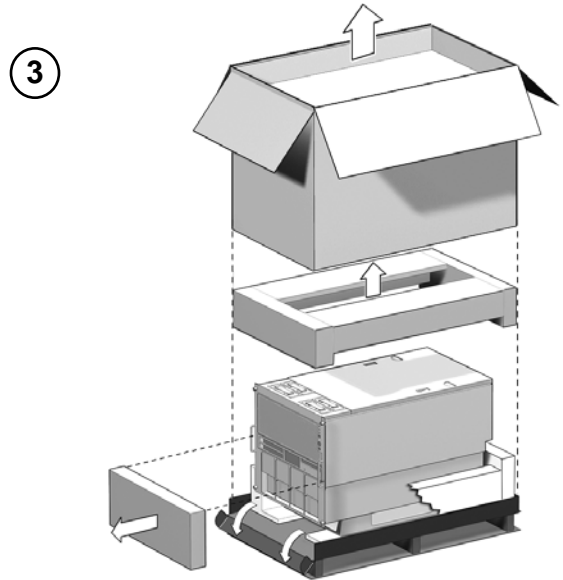
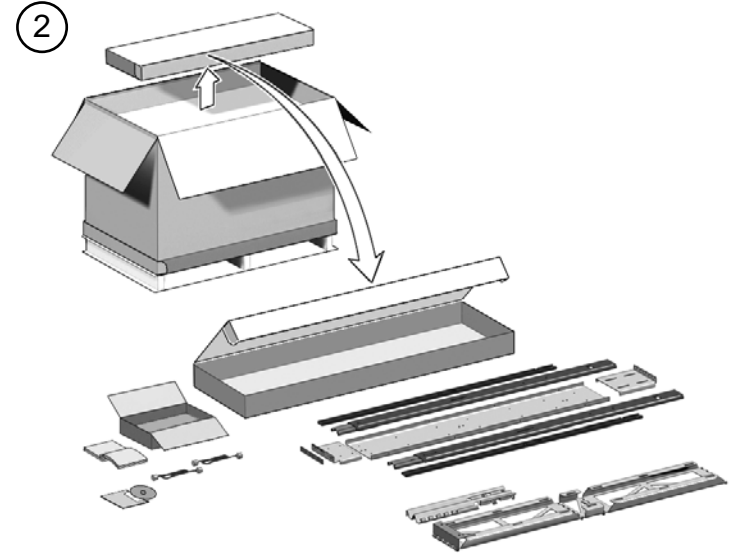
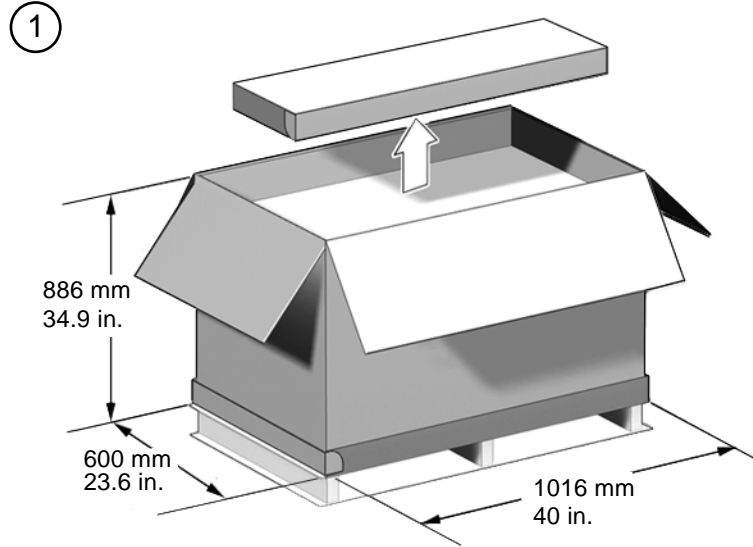

Part No.: 821-3044-10,
Manual Code: C120-E350-02XA
December 2010, Revision A