

POWER RELAY

1 POLE - 12A

FTR-K1 Series

■ FEATURES

- 12A
- 3.5mm and 5.0mm terminal pitch
- Low profile (height: 15.7mm)
- High insulation
Insulation distance (between coil and contacts): 10mm min.
Dielectric strength: 5KV
Surge strength: 10KV
- Low coil power (400mW)
- Cadmium free contacts
- Safety standards
UL, CSA, VDE approved
- UL F class wire insulation
- Flux proof, RT II
- RoHS compliant
Please see page 7 for more information

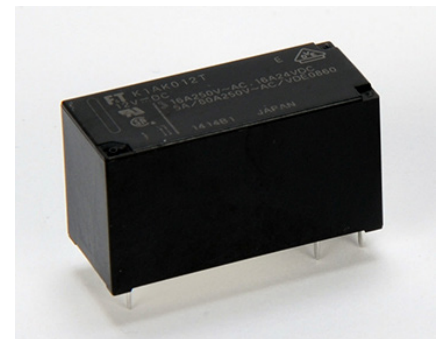

■ PARTNUMBER INFORMATION

[Example] $\frac{\text{FTR-K1}}{\text{(a)}} \quad \frac{\text{C}}{\text{(b)}} \quad \frac{\text{K}}{\text{(c)}} \quad \frac{\text{012}}{\text{(d)}} \quad \frac{\text{W}}{\text{(e)}} - \frac{\text{MA}}{\text{(f)}} - \frac{\text{BG}}{\text{(g)}}$

(a)	Relay type	FTR-K1	: FTR-K1-Series
(b)	Contact configuration	A C	: 1 form A (SPST-NO) : 1 form C (SPDT)
(c)	Coil type / enclosure	K	: Standard (400mW) / flux proof
(d)	Coil rated voltage	012	: 5.....110 VDC Coil rating table at page 3
(e)	Contact material	W	: AgSnO ₂
(f)	Terminal pitch	MA MB	: 3.5mm pitch : 5.0mm pitch
(g)	Special type	Nil BG	: Standard type (without gold plate) : Gold plated 3 μm

Actual marking does not carry the type name : "FTR"

E.g.: Ordering code: FTR-K1CK012W-MA

Actual marking: K1CK012W-MA

FTR-K1 SERIES

■ SPECIFICATION

Item	FTR-K1 (A,C) K () W-MA		FTR-K1 (A,C) K () W-MB	
Contact Data	Configuration		1 form A, 1 form C	
	Construction		Single	
	Material		W: AgSnO ₂	
	Resistance (initial)		Max. 100mΩ at 1A, 6VDC	
	Contact rating (resistive)		12A, 250VAC / 24VDC	
	Max. carrying current * ¹		14A	
	Max. switching voltage		440VAC / 300VDC	
	Max. switching power		3,000VA / 288W	
	Min. switching load * ²		100mA, 5VDC	
Life	Mechanical		Min. 20 x 10 ⁶ operations	
	Electrical	AC contact rating	Min. 100 x 10 ³ operations	
		DC contact rating	Min. 100 x 10 ³ operations	
Coil Data	Rated power (20 °C)		400mW to 430mW	
	Operate power (20 °C)		196mW to 211mW	
	Operating temperature range		-40 °C to +85 °C (no frost)	
Timing Data	Operate (at nominal voltage)		Max. 15ms (without bounce)	
	Release (at nominal voltage)		Max. 5ms (without bounce, no diode)	
Insulation	Resistance (initial)		Min. 1,000MΩ at 500VDC	
	Dielectric strength	Open contacts	1,000VAC (50/60Hz) 1min	
		Contacts to coil	5,000VAC (50/60Hz) 1min	
	Surge strength	Coil to contacts	10,000V / 1.2 x 50μs standard wave	
	Clearance		10mm	
	Creepage		10mm	
	EN61810-1, VDE0435	Voltage		250V
		Pollution degree		3
Material group		III a		
Category		C / 250V (Reference voltage) (VDE0110b)		
Other	Vibration resistance	Misoperation≥1us	10 to 55 to 10Hz single amplitude 0.35mm	
		Endurance	10 to 55 to 10Hz single amplitude 0.75mm	
	Shock	Misoperation≥1us	100m/s ² (11 ± 1ms)	
		Endurance	1,000m/s ² (6 ± 1ms)	
	Weight		Approximately 13g	
	Sealing		Flux proof, RTII	

* 1: Need to consider the heat from PCB when max. current is more than 10A.

* 2: Minimum switching loads mentioned above are reference values. Please perform the confirmation test with actual load before production since reference values may vary according to switching frequencies, environmental conditions and expected reliability levels.

■ COIL RATING

Coil Code	Rated Coil Voltage (VDC)	Coil Resistance +/- 10% (Ohm)	Must Operate Voltage (VDC) *	Must Release-Voltage (VDC) *	Rated Power (mW)
005	5	62	3.5	0.5	400
006	6	90	4.2	0.6	
009	9	202	6.3	0.9	
012	12	360	8.4	1.2	
018	18	810	12.6	1.8	
022	22	1,210	15.4	2.2	
024	24	1,440	16.8	2.4	
028	28	1,960	19.6	2.8	
048	48	5,360	33.6	4.8	430
060	60	8,570	42.0	6.0	420
110	110	28,800	77.0	11.0	

Note: All values in the table are valid for 20°C and zero contact current.

* Specified operate values are valid for pulse wave voltage.

Please use at rated coil voltage. Please refer to characteristic data and set up adequate voltage in case of use at over voltage.

■ SAFETY STANDARDS

Type	Compliance	Contact rating	
		1 Form A	1 Form C
UL	UL 508	Flammability: UL 94-V0 (plastics)	
	E63614	FTR-K1AK()W-(MA, MB) 12A/16A, 24 VDC (resistive), 85°C 12/16A, 277 VAC (resistive), 85°C 1/2hp, 277VAC, 85°C 1/3hp, 125VAC, 85°C Pilot duty: B300, 85°C	FTR-K1CK()W-(MA, MB) 12A/16A, 24 VDC (resistive), 85°C 12A/16A, 277 VAC (resistive), 85°C 1/2hp, 277VAC, 85°C 1/3hp, 125VAC, 85°C 1/8hp, 125VAC, 85°C Pilot duty: B300, 85°C
CSA	C22.2 No. 14 LR 40304	FTR-K1(A,C)K()W-(MA, MB) 12A, 277VAC/24VDC (resistive) 16A, 277 VAC/24VDC (resistive) 1/2 hp, 277VAC 1/3 hp, 125VAC Pilot duty: B300	
VDE	IEC/EN61810-1 EN60335-1 clause 15.3; 16.3; 29.1; 29.2; 29.3 EN60730 clause 12.2; 13.2; 20.1; 20.2; 20.3	FTR-K1(A, C) K ()W-(MA, MB) 12A, 250 VAC (cosφ=1), 85 °C 16A, 250 VAC (cosφ=1), 85 °C 12A, 24VDC (0ms), 85 °C 16A, 24VDC (0ms), 85 °C 3.5A, 250 VAC (cosφ=0.4), 85 °C	

CHARACTERISTIC DATA (Reference)

* Characteristic data is not a guaranteed value, but measured values of samples from production line.

Coil temperature rise

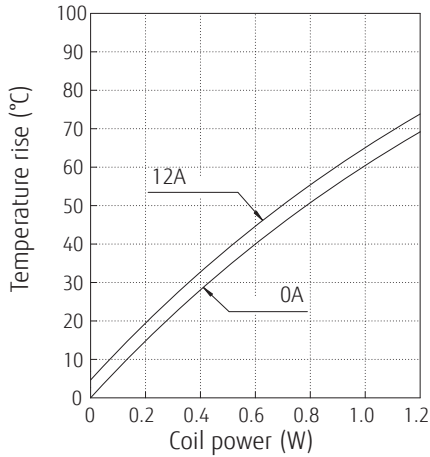

Operating range

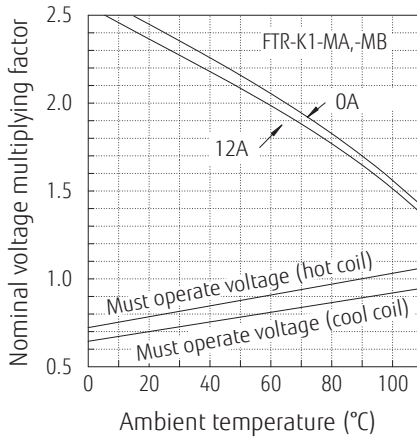

Maximum switching power

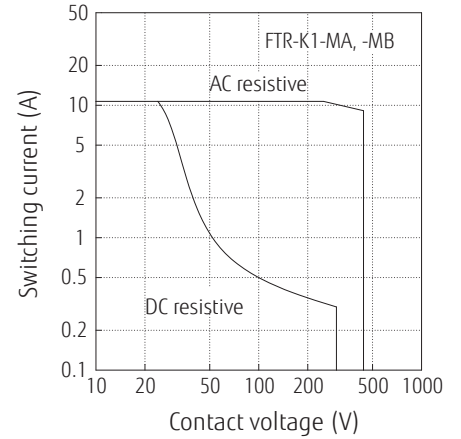

Life curve

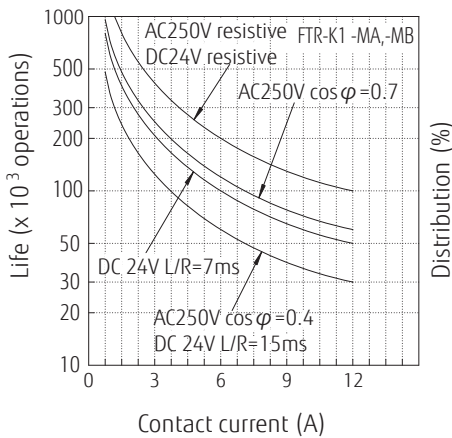

Distribution of operate, release voltage

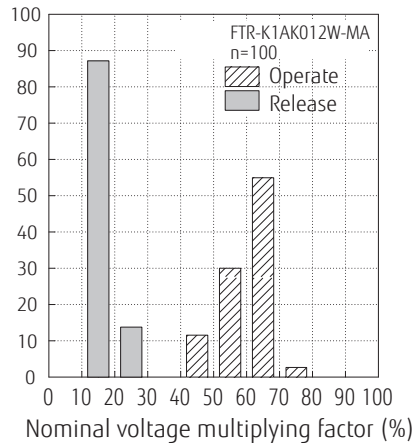

Distribution of operate, release time

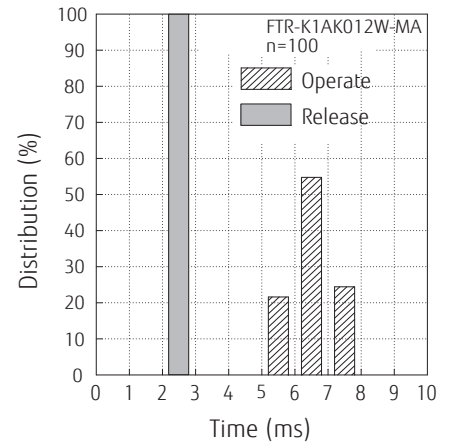

Distribution of contact resistance

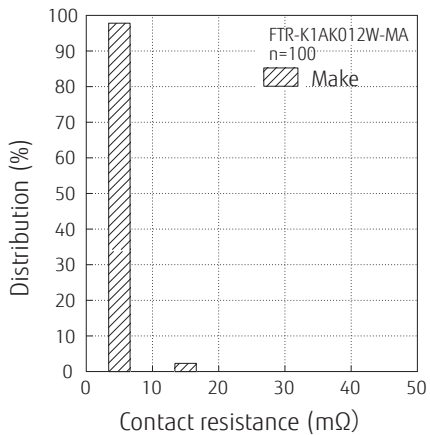

FTR-K1 SERIES

■ DIMENSIONS

FTR-K1AK()W-MA

● Dimensions

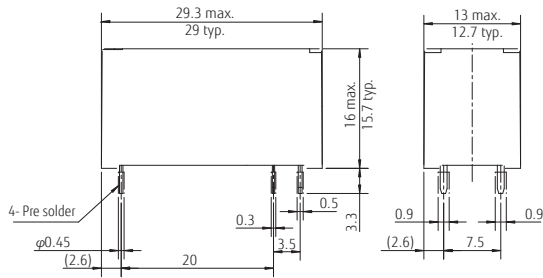

● Schematics

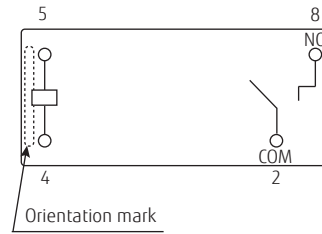

● PC board mounting hole layout (BOTTOM VIEW)

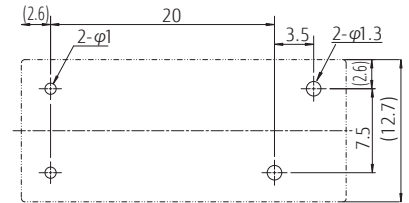

FTR-K1CK()W-MA

● Dimensions

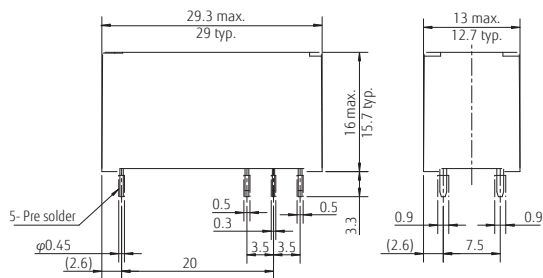

● Schematics

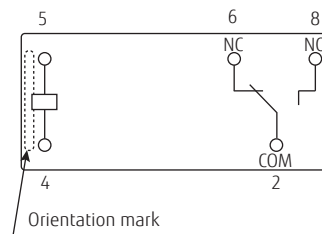

● PC board mounting hole layout (BOTTOM VIEW)

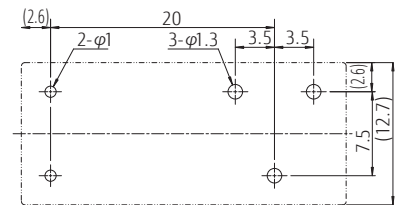

* Dimensions of the terminals do not include thickness of pre-solder.

* Tolerance of PC board mounting hole layout : ± 0.1 unless otherwise specified.

* Dimensions do not include tolerances. Please ask specification in case you need tolerances.

Unit: mm

FTR-K1 SERIES

■ DIMENSIONS

FTR-K1AK()W-MB

● Dimensions

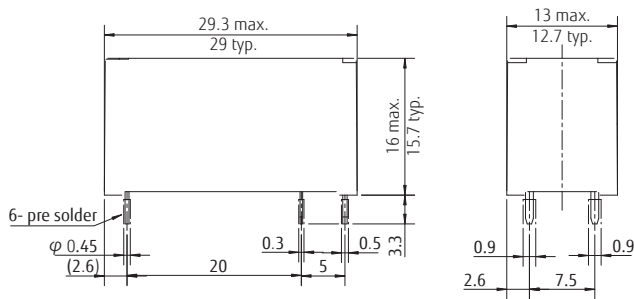

● Schematics

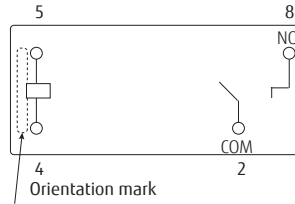

● PC board mounting hole layout (BOTTOM VIEW)

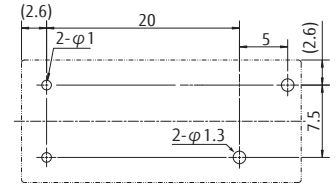

FTR-K1CK()W-MB

● Dimensions

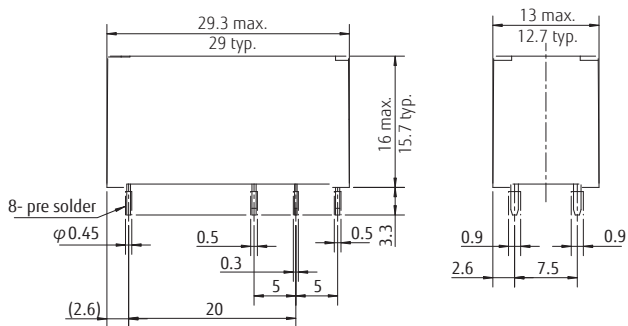

● Schematics

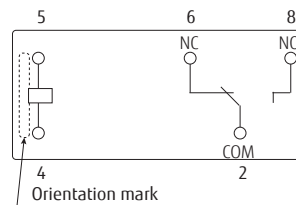

● PC board mounting hole layout (BOTTOM VIEW)

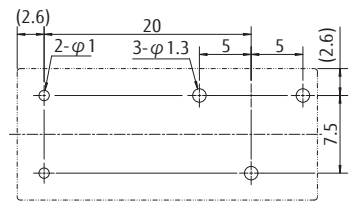

* Dimensions of the terminals do not include thickness of pre-solder.

* Tolerance of PC board mounting hole layout : ± 0.1 unless otherwise specified.

Unit: mm

Cautions

- All values mentioned in this datasheet are provided under ideal conditions. Please perform the confirmation test before actual use.
- Reflow soldering is prohibited.
- Do not use relays in the atmosphere with sulfide gas, chloride gas or nitric oxide. Contact resistance may increase.
- Do not use silicon or silicon-containing product or materials near relays. It may cause contact failure.

RoHS Compliance and Lead Free Information

1. General Information

- All relays produced by Fujitsu Components are compliant with RoHS directive 2011/65/EU including amendments.
- Cadmium as used in electrical contacts is exempted from the RoHS directives. As per Annex III of directive 2011/65/EU.
- All relays are lead-free. Please refer to Lead-Free Status Info for older date codes at: <http://www.fujitsu.com/downloads/MICRO/fcai/relays/lead-free-letter.pdf>
- Lead free solder plating on relay terminals is Sn-3.0Ag-0.5Cu, unless otherwise specified. This material has been verified to be compatible with PbSn assembly process.

2. Recommended Lead Free Solder Condition

- Recommended solder Sn-3.0Ag-0.5Cu.

Flow Solder Condition:

Pre-heating: maximum 120°C
within 90 sec.
Soldering: dip within 5 sec. at
255°C ± 5°C solder bath
Relay must be cooled by air immediately
after soldering

Solder by Soldering Iron:

Soldering Iron 30-60W
Temperature: maximum 350-360°C
Duration: maximum 3 sec.

We highly recommend that you confirm your actual solder conditions

3. Moisture Sensitivity

- Moisture Sensitivity Level standard is not applicable to electromechanical relays, unless otherwise indicated.

4. Tin Whiskers

- Dipped SnAgCu solder is known as presenting a low risk to tin whisker development. No considerable length whisker was found by our in house test.

Fujitsu Components International Headquarter Offices

Japan FUJITSU COMPONENT LIMITED Shinagawa Seaside Park Tower 19F, 12-4, Higashi-shinagawa 4-chome, Shinagawa-ku, Tokyo, 140-0002, Japan Tel: (81-3) 3450-1682 Fax: (81-3) 3474-2385 Email: fcl-contact@cs.jp.fujitsu.com Web: www.fujitsu.com/jp/fcl/	Asia Pacific FUJITSU COMPONENTS ASIA, LTD. 102E Pasir Panjang Road #01-01 Citilink Warehouse Complex Singapore 118529 Tel: (65) 6375-8560 Fax: (65) 6273-3021 Email: fcal@sg.fujitsu.com Web: www.fujitsu.com/sg/products/devices/components	Korea FUJITSU COMPONENTS KOREA LIMITED Alpha Tower #403, 645 Sampyeong-dong, Bundang-gu, Seongnam-si, Gyeonggi-do, 13524 Korea Tel: (82) 31-708-7108 Fax: (82) 31-709-7108 Email: fcal@sg.fujitsu.com www.fujitsu.com/sg/products/devices/components/
North and South America FUJITSU COMPONENTS AMERICA, INC 2290 North First Street, Suite 212 San Jose, CA 95131, USA Tel: (1-408) 745-4900 Fax: (1-408) 745-4970 Email: components@us.fujitsu.com Web: us.fujitsu.com/components	China FUJITSU ELECTRONIC COMPONENTS (SHANGHAI) CO., LTD. Unit 4306, InterContinental Center 100 Yu Tong Road, Shanghai 200070, China Tel: (86-21) 3253 0998 Fax: (86-21) 3253 0997 Email: fcal@sg.fujitsu.com Web: www.fujitsu.com/sg/products/devices/components	
Europe FUJITSU COMPONENTS EUROPE B.V. Diamantlaan 25 2132 WV Hoofddorp Netherlands Tel: (31-23) 5560910 Fax: (31-23) 5560950 Email: info@fceu.fujitsu.com Web: www.fujitsu.com/uk/components	Hong Kong FUJITSU COMPONENTS HONG KONG CO., LTD Unit 506, Inter-Continental Plaza No.94 Granville Road, Tsim Sha Tsui, Kowloon, Hong Kong Tel: (852) 2881-8495 Tex: (852) 2894-9512 Email: fcal@sg.fujitsu.com Web: www.fujitsu.com/sg/products/devices/components/	

©2019 Fujitsu Components Europe B.V. All rights reserved. All trademarks or registered trademarks are the property of their respective owners.

The contents, data and information in this datasheet are provided by Fujitsu Component Ltd. as a service only to its user and only for general information purposes.

The use of the contents, data and information provided in this datasheet is at the users' own risk.

Fujitsu has assembled this datasheet with care and will endeavor to keep the contents, data and information correct, accurate, comprehensive, complete and up to date.

Fujitsu Components Europe B.V. and affiliated companies do however not accept any responsibility or liability on their behalf, nor on behalf of its employees, for any loss or damage, direct, indirect or consequential, with respect to this datasheet, its contents, data, and information and related graphics and the correctness, reliability, accuracy, comprehensiveness, usefulness, availability and completeness thereof.

Nor do Fujitsu Components Europe B.V. and affiliated companies accept on their behalf, nor on behalf of its employees, any responsibility or liability for any representation or warrant of any kind, express or implied, including warranties of any kind for merchantability or fitness for particular use, with respect to these datasheets, its contents, data, information and related graphics and the correctness, reliability, accuracy, comprehensiveness, usefulness, availability and completeness thereof. Rev. January 23, 2019