

4G Femtocell Solutions for Stadium Environments

Football stadiums are extreme instances of traffic hotspots. Currently in stadium settings, most operators use cellular solutions for voice and Wi-Fi for data. While this may be adequate for now, forecasts of exponential growth in user traffic (especially real-time video), this type of solution will not be sufficient in the future since Wi-Fi cannot provide QoS and the conventional cellular network will not have enough capacity.

Using multimode femtocells (4G plus Wi-Fi) to replace the existing Wi-Fi APs is a viable solution, but this effectively forms a multilayer HetNet, which presents challenging inter-layer interference problems between the outdoor-cell layer and indoor-cell layer. We propose four possible solutions to address the interference issue. There are two near-term solutions in addition to an intermediate-term and a long-term solution.

Special Characteristics of Stadiums

Large buildings are typically three-dimensional hotspots in terms of wireless traffic. A football stadium can be considered an extreme type of hotspot with some special characteristics:

- **Extremely high user density:** each stadium can hold 20,000 to 90,000 people; most of them are wireless users. As more and more people have upgraded to smartphones and begun to use bandwidth-intensive applications like mobile video, wireless operators face unique challenges to provide sufficient capacity to stadiums while maintaining adequate QoS.
- **Highly variable BPL values:** BPL can be highly variable from one type of stadium to another. Some stadiums have roofs with steel-enforced structures which cause high penetration loss. Other stadiums have no roofs at all so the BPL values are very low. In these cases the in-building areas will face strong interference from outdoor networks.

Careful consideration should be given to the unique situations and special characteristics of each stadium.

There are two common approaches to increase wireless capacity:

- **Stay within the cellular band:** This situation requires a smaller cell for higher capacity. For a given spectrum bandwidth, an effective way to increase capacity per unit area is to shrink the coverage footprint of each cell and increase the total cell count so the same area is served by a large number of small cells[1].
- **Expand the operating band:** This case suggests using cellular plus Wi-Fi. Wi-Fi, operating on 2.4 GHz or higher frequencies, is an ideal candidate that can offload data traffic from the cellular and the two networks can coexist in an overlaid fashion.

In the case of football stadiums, most operators currently use cellular (microcells or picocells) to provide real time services (such as voice) and use Wi-Fi to serve the best-effort traffic (such as Web browsing). A schematic diagram of the overlaid network with cellular and Wi-Fi is shown in Figure 1.



Figure 1: Schematic diagram of overlaid network with cellular and Wi-Fi

While this arrangement may be adequate for now, it will cease to be sufficient as bandwidth-intensive real time applications like mobile video become dominant. It was forecast that between 2013 and 2014, mobile video will start to dominate wireless traffic overall; by 2016, up to 70% of total wireless traffic will be mobile video, as shown in Figure 2.

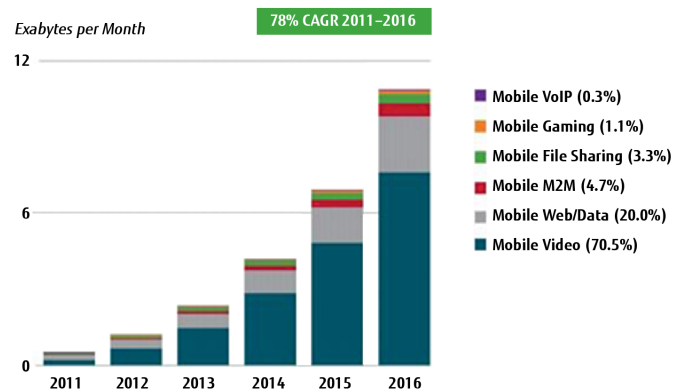

Figures in legend refer to traffic share in 2016. Source: Cisco VNI Mobile, 2012

Figure 2: Forecast for wireless traffic mix: by 2016, mobile video will occupy 70% of total traffic

When mobile video traffic dominates, under the current arrangement, which network should handle the video traffic? Since video is a real time application, it should be handled by the cellular network. But the cellular network will not provide sufficient capacity for this kind of demand. The smallest picocell radius is approximately 100 meters, so one stadium can be served by at most a few picocells (Figure 3).

Even if only a small percentage of the 20,000–90,000 people in the stadium are viewing online videos, the traffic load is sufficient to overload the cellular network. Wi-Fi, on the other hand, cannot provide sufficient QoS, and should thus only be used to offload best-effort traffic.

In this white paper, a femtocell solution is proposed to enhance the in-building capacity in the stadium. A large number of multimode (Wi-Fi + 4G) femtocells are used to replace the existing Wi-Fi APs.

- **For Wi-Fi networks:** The number of APs will be increased but there is no architectural change.
- **For cellular networks:** The network architecture is changed from single layer to multilayer, forming a heterogeneous network (HetNet).



(a) Ceiling Deployment

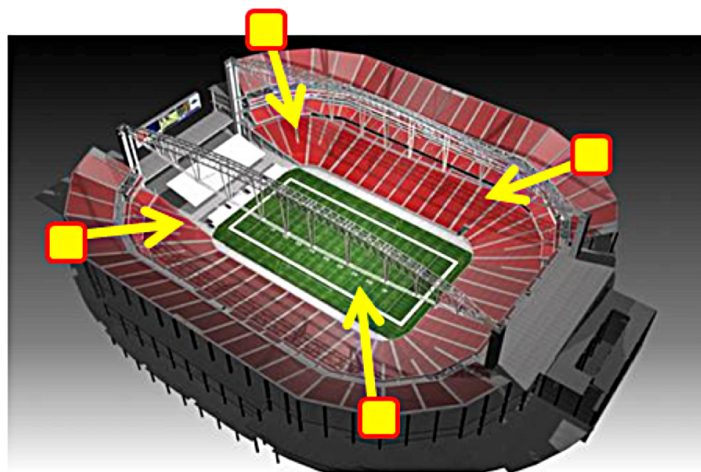

(b) Sidewall Deployment

Figure 3: If picocells are used to serve a stadium, only a small number can be used.

The first issue that must be solved for a HetNet deployment is the challenging inter-layer interference problem between the outdoor cell layer and indoor (femtocell) layer.

The following sections discuss the general approaches to boost indoor capacity, address the potential interference issues, and propose four solutions to deploy 4G femtocells to stadiums.

Femtocells: Smaller Cells for Higher Capacity

Note that there are two very different in-building service objectives.

- **Maximizing in-building coverage:** To achieve this goal, the footprint from each indoor cell should be as large as possible in order to minimize the total indoor cell count
- **Maximizing in-building capacity:** To achieve this goal, the footprint from each indoor cell should be as small as possible in order to maximize the total indoor cell count and consequently increase the maximum capacity.

Obviously when serving stadiums, the main goal is to maximize the in-building capacity, which requires minimizing, rather than maximizing, the coverage footprint of each indoor cell.

Data capacity from a cell is defined as the aggregate cell throughput. With identical conditions (e.g., the same channel bandwidth), the aggregate throughput from one cell is the same regardless of cell sizes. That means regardless of whether it is a macrocell, microcell, picocell, or femtocell, the aggregate cell throughput from each cell is the same. It also means that total capacity is inversely proportional to the square of the cell radii; if the cell radii are halved, the total capacity is quadrupled (Figure 4).

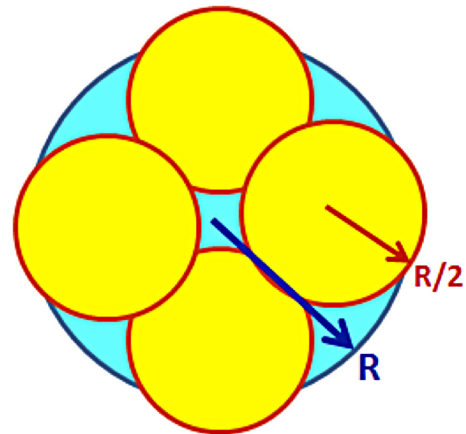

Figure 4: Half the cell radii will quadruple the total capacity.

4G Femtocell for Football Stadiums

The total capacity from the stadium can be increased significantly by using a large number of femtocells with very small footprints. The cell radii of femtocells can be reduced to about 10–30% of those of picocells; which means by using femtocells, the total indoor capacity can be increased by a factor of 10–100 times (Figure 5).

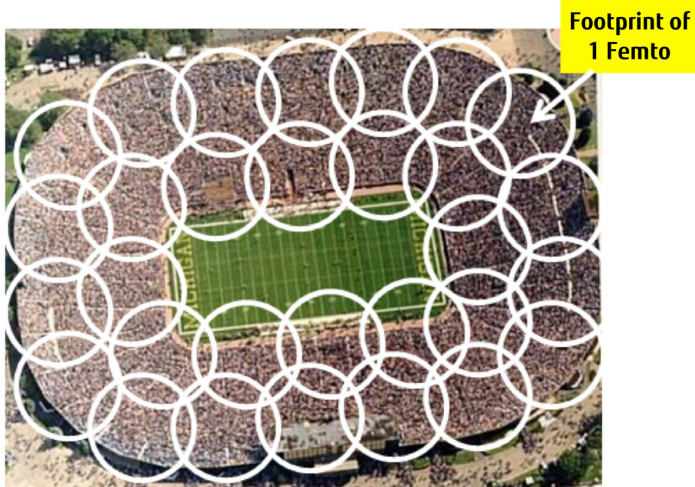

Figure 5: With small footprints, a much larger number of femtocells can be used to cover the stadium

There are two approaches to make the coverage footprint of each femtocells as small as possible:

- Reduce the TX power level and reduce receiver sensitivities. Obviously this reduces link budget and shrinks coverage footprint.
- Reduce the effective antenna height. The lower the effective antenna height, the steeper the propagation path-loss slope will be, which means the faster the signal will attenuate with distance. To make smallest footprints, the effective antenna heights should be as close to ground level as possible.

The Tx power level from a femtocell is typically of the order of 10–50 mW, much lower than the typical Tx power levels of microcell/picocell.

Currently most Wi-Fi APs are installed either on the ceiling or on the walls, with effective antenna heights of more than 3 m. The femtocell coverage footprint can be minimized by installing femtocell antennas very close to the ground level (< 0.5 m). An example is femtocell antennas built inside some types of enclosure located next to the seats, as shown in Figure 6.

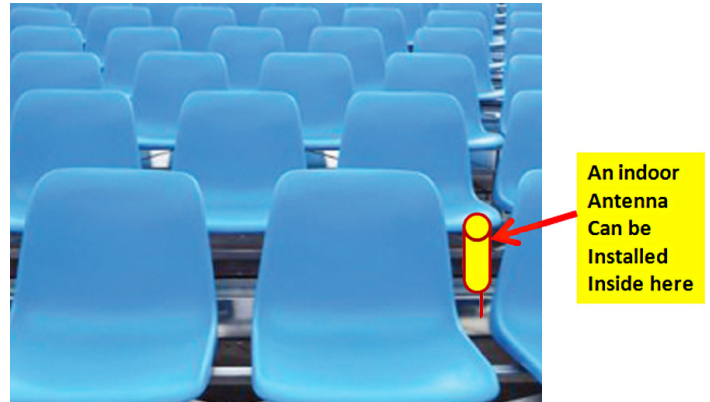

Figure 6: Femtocell antennas can be installed very close to ground level

Furthermore, because the elevation levels of seats in a stadium gradually increase as the seats are located farther away from the center, the vertical patterns of the femtocells should also be tilted slightly to best match the inclined angle of the “ground” (Figure 7).

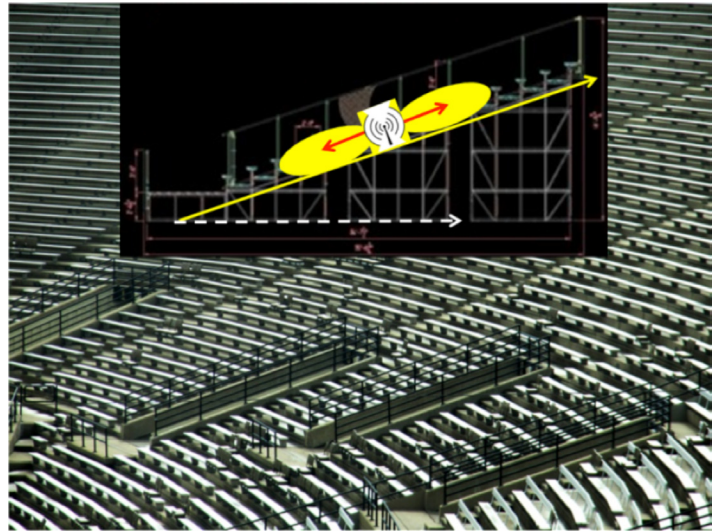

Figure 7: The vertical beam pattern of the femtocell should be tilted to best match the inclined “ground” level

One “luxury” the stadium environment has, is that one can install femtocells with equal inter-cell distance so the femtocell network inside the stadium forms a “regular lattice,” which effectively reduces inter-cell interference (Figure 8).

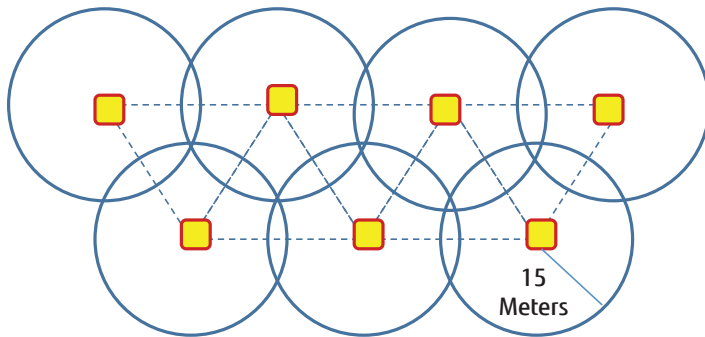

Figure 8: Femtocells in the stadium form a regular lattice

It is the randomness of HeNB locations in a typical residential femtocell deployment that causes high inter-cell interference because some HeNBs may be located too close to each other (Figure 9, left). If the femtocells form a regular lattice (Figure 9, right), the worst-case cell-edge SINR will not be much lower than -5 dB. In contrast, for irregular cell locations the SINR distribution typically has a long tail with the worst-case cell-edge SINR values lower than -10 dB.

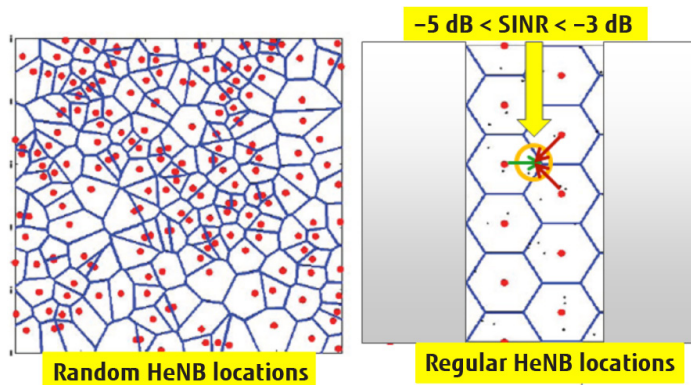

Figure 9: Random cell locations vs. regular cell locations

If femtocells can be placed regularly as shown in Figure 8, inter-cell interference within the femtocell layer is not an issue because LTE channels can perform adequately when cell-edge SINR ~ -5 dB, so interference control features like ICIC may not be needed. However, for inter-layer interference, i.e., the interference between the femtocell layer and outdoor macrocell layer, it is an entirely different situation. The inter-layer interference can be a serious issue here.

Outdoor Network Around the Stadium

A typical situation is that macrocells are deployed for ubiquitous outdoor coverage. For outdoor areas near the stadium (roads near the stadium, packing lots, etc.) traffic density will be higher as people are entering the stadium or leaving the stadium. So these areas are usually covered by a few outdoor microcells, or outdoor picocells (Figure 10).

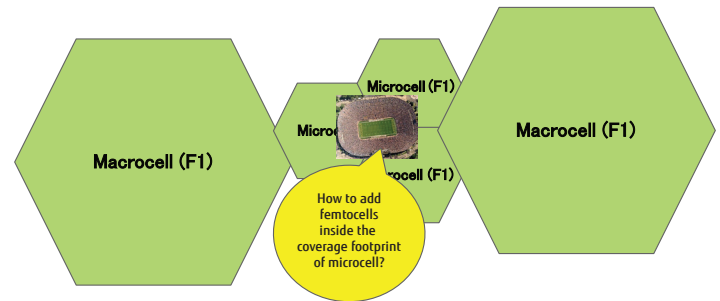

Figure 10: Outdoor networks around the stadium

These microcells or picocells typically have LOS conditions from the stadium, so in addition to providing outdoor service to areas around the stadium, they also have strong coverage inside the stadium unless the stadium BPL is very high (Figure 11). In this white paper, the worst-case assumption is used with minimum BPL from the stadium assumed.

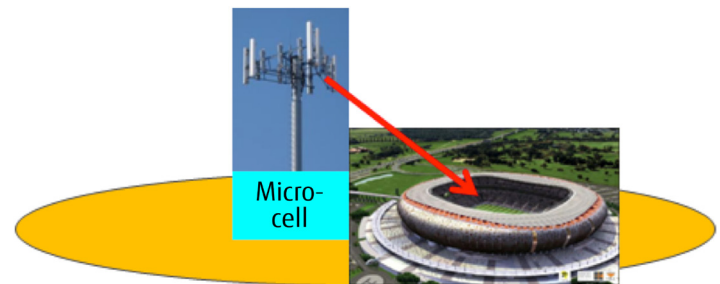

Figure 11: Outdoor microcells typically have LOS condition with the stadium

The strong coverage from outdoor cells inside the stadium will cause strong interference if femtocells are added to the stadium with co-channel deployment. This is the main reason most operators prefer to use Wi-Fi at 2.4 GHz for indoor service in order to avoid this type of interference.

General Discussion of Interference Mitigation Techniques

There are several different approaches to mitigate interference in a cellular system. Examples are described in this section.

Interference Cancellation

Advanced receiver techniques can be used to cancel the unwanted interference and enhance the final achieved signal-to-interference ratio. Interference cancellation is one of the topics in LTE-advanced (Release 12) and is briefly discussed in this paper's section on the long-term solution.

Interference Avoidance

Examples of interference avoidance techniques are ICIC and eICIC. Interference avoidance is the main topic of this white paper.

LTE uses OFDM on the DL and SC-OFDM on the UL. To avoid interference, there are two domains to work with: the time domain or and frequency domain. There is also a third domain, the power domain. This domain is usually combined with either the frequency domain or time domain.

- A "collision" happens if more than one eNB or more than one UE transmit on the same frequency and at the same time (i.e., the same "area" in the frequency-time space), so they directly interfere with each other.
- For OFDMA systems, multiple techniques can be used to avoid collision, i.e., try to avoid each other either in the frequency domain, or in the time domain (Figure 12). The power domain can be combined with either frequency or time domain.

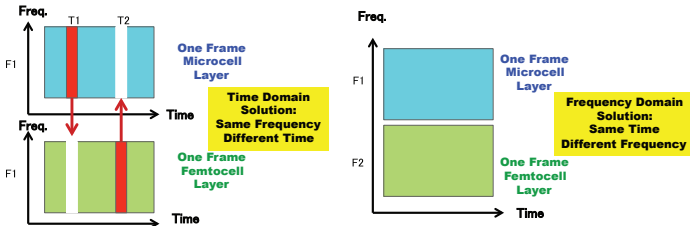

Figure 12: ICIC can work either on the time domain or on the frequency domain

The single-carrier property of the LTE uplink makes it very convenient for various frequency domain solutions to be used. Figure 13 shows one possible frequency-domain solution to avoid PUCCH interference between the macrocell-layer and femtocell-layer by using different PUCCH frequencies from two different layers.

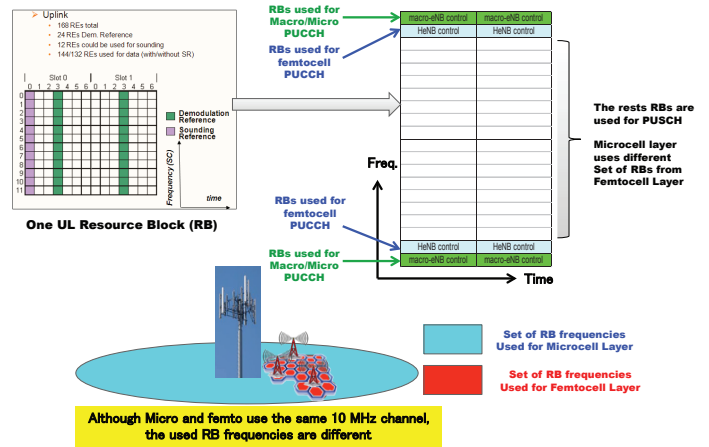

Figure 13: PUCCH interference avoidance

Another example of a frequency-domain solution to avoid cell-edge user interference is the well-known FFR. Figure 14 shows DL traffic channel FFR.

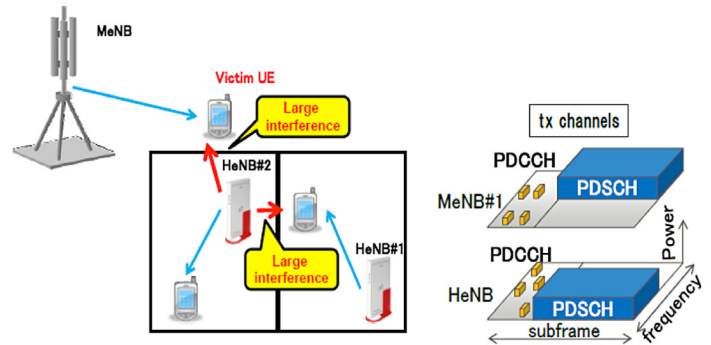

Figure 14: Frequency domain ICIC for PDSCH

Not every channel is well-suited for frequency domain solutions. For example, PDCCH must occupy the full channel bandwidth so it is difficult for the frequency domain ICIC to work on PDCCH. A time domain solution is proposed for LTE-advanced called "almost-blank-subframes" (ABS) [2]-[6]. In ABS, the interferer (the macrocell-layer in this case) is purposely "mute" on some of the subframes, so very little interference is experienced at the victim (the femtocell layer in this case) from these "almost blank" subframes. The victim can use these "interference-free" subframes to transmit (Figure 15).

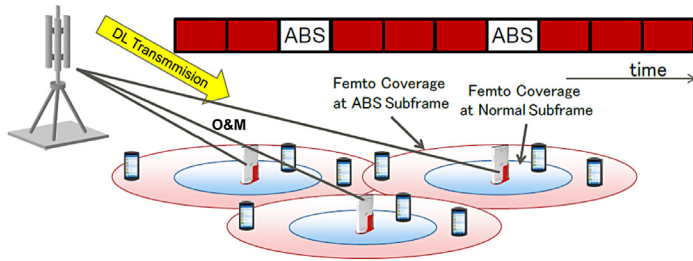

Figure 15: Illustration of ABS

The ABS pattern must be communicated between the two layers. For HetNet with macrocells and picocells, a bit-map pattern is communicated between the two layers via an X2 interface. For HetNet with macrocells and femtocells, the ABS pattern is configured semi-statically and controlled via an Operation and Maintenance (O&M) center, as shown in Figure 16.

ABS is an important time domain solution in eICIC.

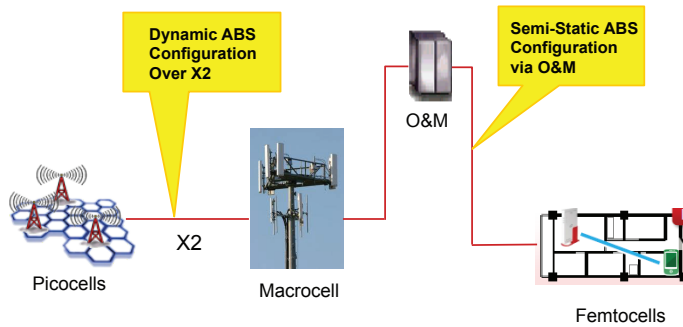

Figure 16: Communication of ABS among different layers

Recommended Deployment Solutions

Four sets of solutions are recommended for 4G femtocell deployment in stadiums:

- **Near-term solution 1:** This is the simplest solution and requires no additional product development, so it can be implemented immediately.
- **Near-term solution 2:** This uses Fujitsu proprietary interference mitigation solutions. These features are either available now or will be available much sooner than the solutions like eICIC/ABS which are scheduled for 3GPP Release 10.
- **Intermediate-term solution:** This requires eICIC features which will be available in 3GPP Release 10.
- **Long term solution:** This requires additional spectra in the high frequency bands and new products accommodating the new bands. They will be available in 3GPP Release 12.

Near-Term Solution 1: Static Frequency Partition

The easiest way to deploy a HetNet without causing significant inter-layer interference is using different carrier frequencies for the outdoor layer and indoor layer. If the outdoor carrier and indoor carrier use adjacent frequencies, there will still be adjacent channel interference, but due to the selectivity of channel filters, adjacent channel interference is much less severe compared to the co-channel interference.

Figure 17 illustrates one possible implementation of this solution. Assume the LTE network normally uses 10 MHz channel bandwidth. The outdoor macrocells located physically far away from the stadium will still use the full 10 MHz. The microcells located near the stadium (covering the roads and parking lots near the stadium) will use one 5 MHz channel; the femtocells in the stadium use a different 5 MHz channel. The two 5 MHz channels can be adjacent.

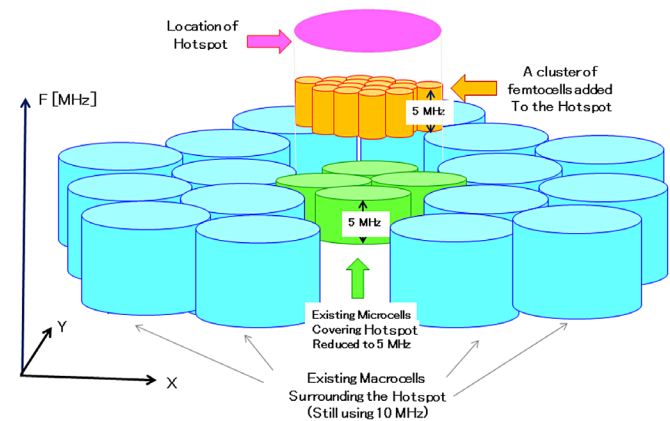

Figure 17: Solution with Femtocells and Microcells use different carrier frequencies

By using only 5 MHz channel bandwidth, both microcell capacity and femtocell capacity are reduced by half if 10 MHz is used. However, as discussed in Section 2, adding a large number of femtocells will increase indoor capacity by at least one order of magnitude, so the capacity gain of adding femtocells far exceeds the capacity loss due to the narrower channel bandwidth. One can, however, increase the overall capacity even more.

Although using non-overlapping carriers completely eliminates co-channel interference between the indoor-cell and outdoor-cell layers, this is not always necessary. The overall capacity can be higher if femtocells use the full bandwidth of 10 MHz, only microcells located near the stadium reduces bandwidth to 5 MHz. This scheme is shown in Figure 18.

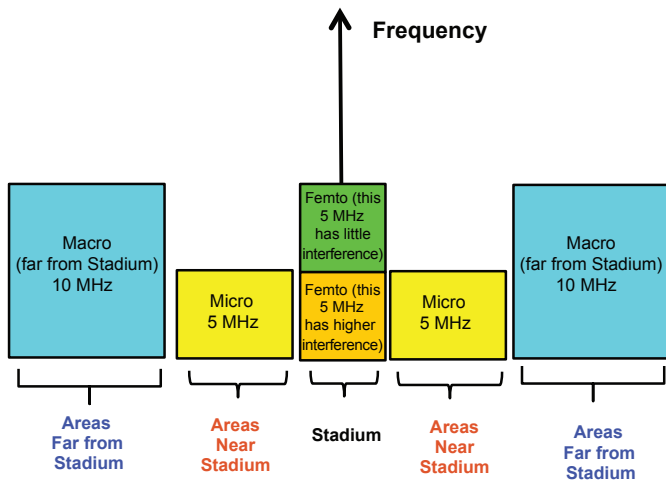

Figure 18: Femtocells can use 10 MHz without excessive interference

The reason the outdoor-cell-layer (microcells) should reduce the channel bandwidth is that the major interference is from outdoor-cell-layer to femtocell-layer (Figure 11), so the outdoor-cell layer must reduce its bandwidth so interference only happens on half of the femtocell carrier (Figure 19).

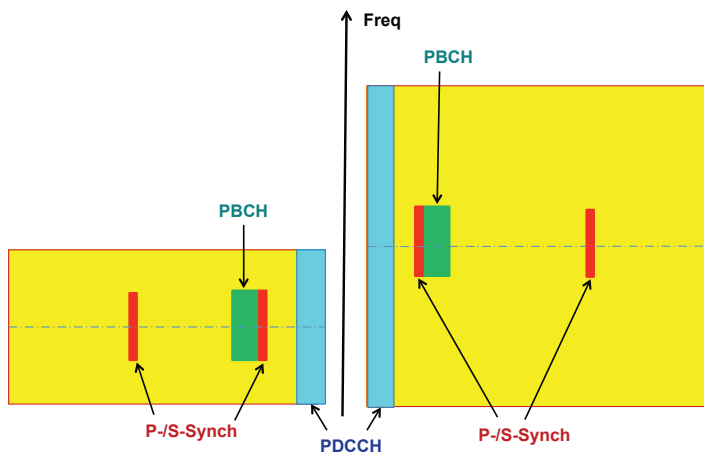

Figure 19: Inter-layer interference will only happen to half of the carrier of the femtocells

For traffic channels:

Femtocell users located near the cell center can use the full 10 MHz of channel bandwidth. The choice of bandwidth to use for femtocell users located near the cell edge depends on the current interference level measured from the outdoor-cell layer:

- If the interference level from the outdoor-cell layer is not too strong, cell-edge users can still use the full 10 MHz bandwidth.
- If the interference from the microcell layer is too strong, then restrict the femtocell UE cell-edge allocated RB frequencies to the 5 MHz not overlapping with the outdoor-cell layer.
- The current frequency-domain ICIC algorithm for traffic channels can perform this task without further product development.

For overhead channels:

- PBCH, P-/S-Synch of microcell layer and femtocell layer will no longer collide on top of each other due to the 2.5 MHz frequency offset between the two layers (Figure 19).
- Only half the femtocell PDCCH will be impacted by the outdoor-cell-layer. DL control information can still be delivered from un-impacted part of control-channel-elements (CCEs) due to the CCE scrambling [7].

Figure 20 shows different handover scenarios as users move between cells with 5MHz channels and cells with 10 MHz channels [8].

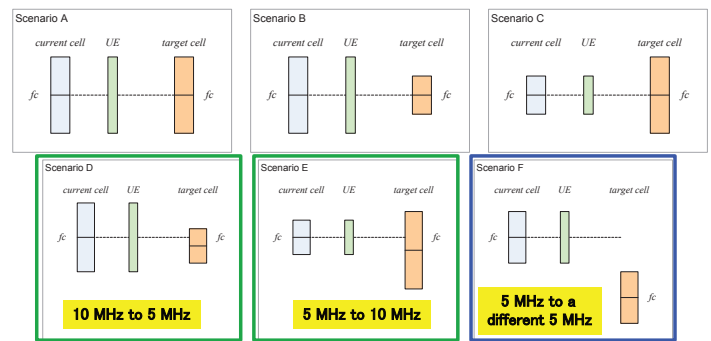

Figure 20: Handover between cells with different carrier frequencies and/or different channel bandwidth

The main shortcoming of fixed frequency partitions is that it is not a very flexible solution. If traffic loads are dynamically changing, a dynamic solution will work better.

The traffic load in the stadium and the surrounding areas can be dynamic. For example, before the game, most people are driving to the stadium; after the game, most people are leaving the stadium. During these periods, the roads near the stadium and parking lots near the stadium are very busy so the microcells surrounding the stadium need more capacity, but the indoor femtocells do not need very high capacity. When all users are inside the stadium, the indoor femtocells need high capacity but the outdoor microcells no longer need high capacity.

Note, however, that most video traffic will be from indoor users, simply because driving people are less likely making video calls. Nevertheless, it is desirable to also increase microcell bandwidth to 10 MHz. This will result in a co-channel HetNet deployment if both indoor cells and outdoor cells use the same 10 MHz, so additional interference mitigation techniques are needed.

Near-Term Solution 2: Fujitsu Proprietary Interference Control (IC)

Features in eIC will not be available before LTE-Advanced. However, Release-9 femtocells do face the same inter-layer interference issues so proprietary solutions can be used. These proprietary solutions can be combined with the Release 10 features once those become available.

Fujitsu proprietary solutions take a cognitive and learning approach on its interference control (IC) algorithms, which requires minimum assistance from the macrocells. The femtocell can “learn” the current interference situations by making multiple measurements. The femtocell can also estimate the current locations of UEs from their feedback. From these inputs, the RF resources are allocated in an optimum way to maximize capacity and minimize interference (Figure 21).

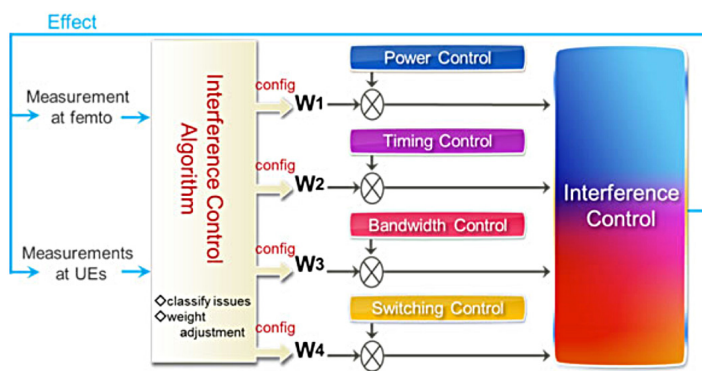

Figure 21: Cognitive and learning interference control

As shown in figure 21, there are four main components in the IC mechanism:

- (1) **Power Domain IC:** This includes RS power boosting, traffic channel power boost/power backup, and CCE-based power boost. The effect of traffic and RS power boost is shown in Figure 22.

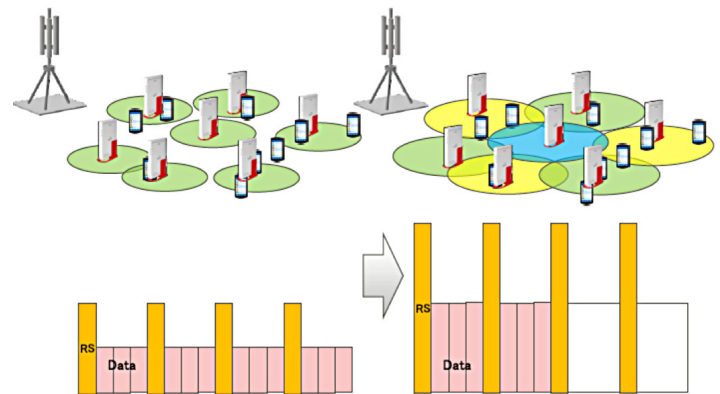

Figure 22: Power boosting to expand coverage footprints

- (2) **Frequency Domain IC:** This is also known as Bandwidth Control, which is a dynamic FFR algorithm [9] with additional intelligence. The frequency allocation in a fixed FFR will not change because of different user locations. This dynamic FFR can optimally allocate RF resources based on current user locations. It will reduce interference to areas with high user density at the expense of increasing interference to locations with no user, as shown in Figure 23.

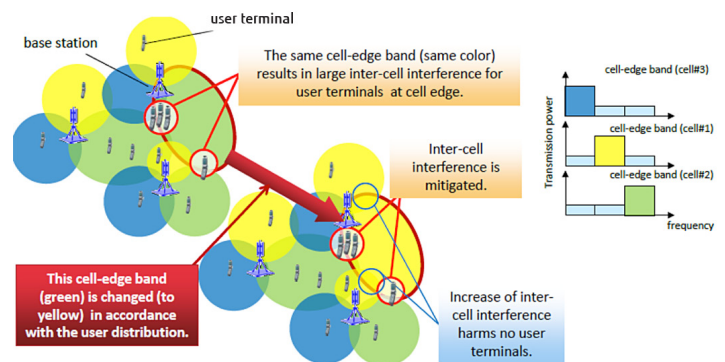

Figure 23: Intelligent dynamic FFR allocates RF resources based on user locations

(3) **Cell Boundary Control:** This is a centrally controlled intelligent algorithm that can adjust the TX power levels of different femtocells to produce overall optimum coverage footprints based on current user locations. As shown in Figure 24, when the algorithm is applied, some previous cell-edge users will no longer be on the cell edge. In addition to this centrally controlled mechanism, each individual femtocell can control its TX power based on the currently measured interference level.

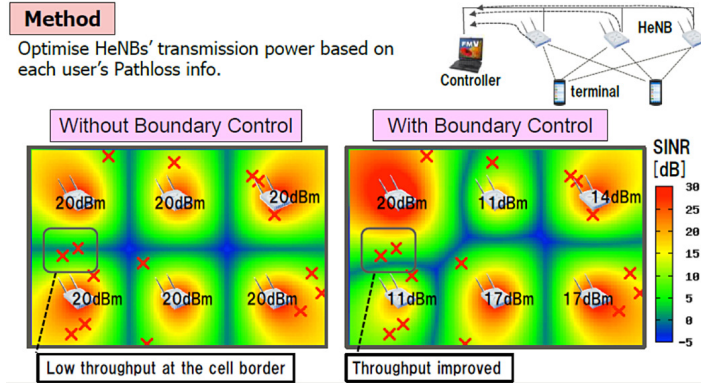

Figure 24: Femtocell footprints are changed to provide optimum services based on current user locations

(4) **LTE/ Wi-Fi Switching Control:** If interference from the macrocell layer is so large that the coverage footprints of femtocells shrink too much, the femtocell network will direct femtocell UE to switch to Wi-Fi, as shown in Figure 25.

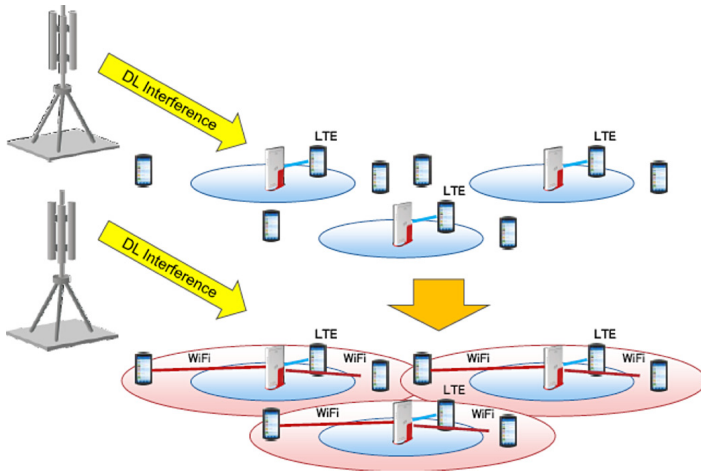

Figure 25: LTE/Wi-Fi switching feature.

This four-component cognitive and learning interference control mechanism has been shown to produce similar performance to eICIC in most cases. Because it is available much sooner than eICIC, it can work as the second near-term solution.

Intermediate-Term Solution: Dynamic eICIC

Dynamic eICIC algorithms can be combined with Fujitsu proprietary IC algorithms to further enhance overall performance, after Release 10 is available.

When the femtocell layer and outdoor-cell layer both use the full bandwidth (e.g., 10 MHz), dynamic eICIC can be switched "on" and "off" based on the dynamic situation of traffic loads. For example, the eICIC only needs to be "on" for a few hours, including a sufficient time window before and after the game. At other times, there are very few users inside the stadium so both femtocells and eICIC can be switched off, which means letting outdoor microcells provide service to indoor and outdoor service areas.

Figure 26 shows a curve of loading level vs. time for a typical football stadium.

- When there is no game, the load level inside the stadium is almost zero.
- Traffic load starts to increase 1 or 2 hours before the game; and two peaks usually happens before and after the game.
- The load level during the game is slightly lower than the two peaks
- The load level slowly decreases after the second peak. As people are leaving the stadium, the load level from the stadium slowly drops.

Traffic Volume vs. Time

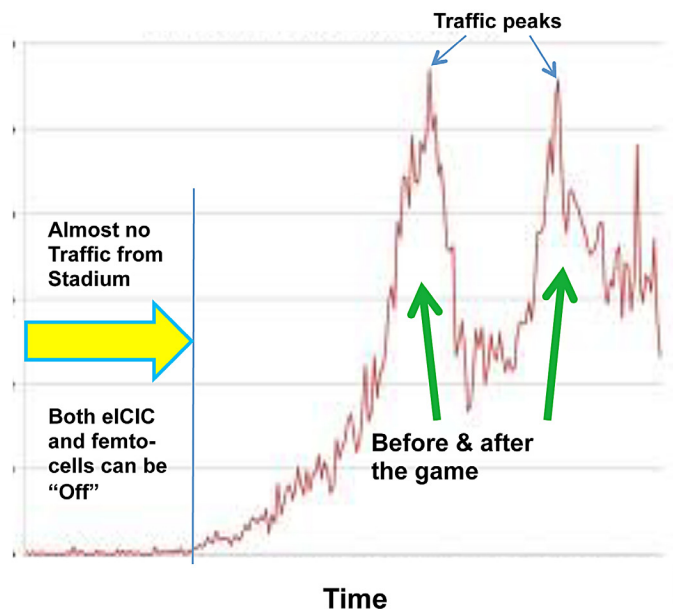

Figure 26: Load level vs. time for a typical stadium



The main advantage of near-term solution 2 and the intermediate-term solution over near-term solution 1 is full utilization of the spectrum. Nevertheless, eCIC algorithms such as ABS do restrict resource allocations (i.e., some subframes are “almost blank”) so there will still be capacity impacts on the layer that is performing the “blanking” (the microcells in this case).

3GPP Release 12 puts significant emphasis on enhancing small cell performance [10]-[17]. New spectra will be opened and new mechanisms are proposed which will significantly enhance the capacity and performance of HetNet. These features can be used as long-term solutions to 4G femtocell deployment to football stadiums.

Long-Term Solution: New Enhancements in Release 12

One of the major tasks of Release 12 is the so-called Local Area Enhancement, which will significantly enhance small cell capacity and performance. There are two approaches for LTE Local Area Enhancements: stand-alone cells and soft cells.

- Stand-alone low-power nodes (LPNs) with new carrier types (“lean carriers”), with no assistance from overlaying macrocells.
- Soft Cells: LPNs with assistance from macrocells. UEs have dual connectivity with anchor and booster carriers.
 - Anchor carrier: macrocell node connection with system information
 - Booster carrier: LPN connection for large volume data, ultra-lean transmission with minimum overhead

Currently, femtocells must use the cellular bands which are also used by picocells, microcells and macrocells, so HetNet will face inter-layer interference. Release 12 will open new spectra from high-frequency bands (3 ~ 5 GHz) for small cells. Multi-layer HetNets (large and small cells, or large, medium and small cells) can be deployed with large cells providing ubiquitous coverage/mobility and small cells (LPN) optimized for data (Figure 27).

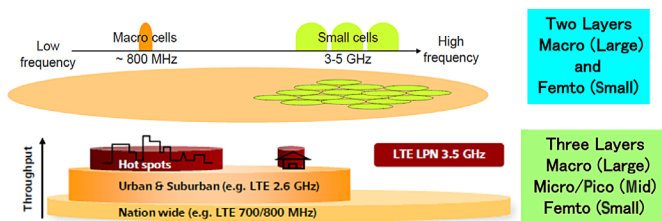

Figure 27: Multilayer HetNet using different frequency bands

There are many advantages of using high-frequency bands for femtocell:

- Available bandwidth from high-frequency bands is much wider compared to that from cellular bands; wide bandwidth allows much higher capacity for femtocells.
- A combined solution of Wi-Fi and cellular is used in today’s stadiums to avoid inter-layer interference. If femtocells use high-frequency bands, there will no longer be inter-layer interference, thereby avoiding the main interference problem.
- RF energy from high-frequency bands attenuates much faster with distance. This makes it perfect for small cell applications: there will be much less unwanted “signal overshoot” thus less out-of-cell interference among the neighboring femtocells.

In addition to the added high-frequency bands, Release 12 also added new features such as inter-band carrier aggregations, interference-cancelling receivers, and integration of Wi-Fi with LTE (Figure 28).

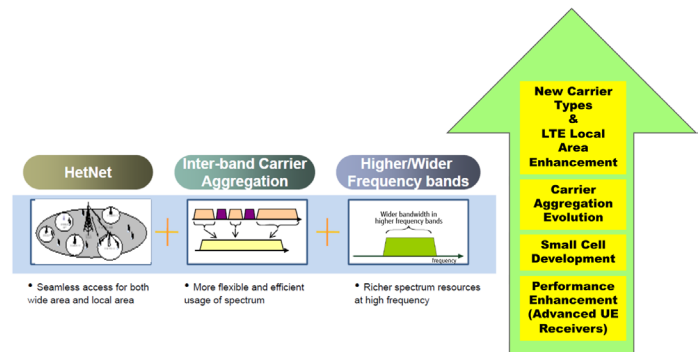

Figure 28: Release 12 enhancements for small cells

- Inter-band carrier aggregation: new UE will be able to use both cellular band carriers and carriers in high-frequency bands, which significantly increases user throughput.
- Interference-cancelling receiver: More advanced receivers with inter-cell-interference rejection capabilities will be available to further mitigate the intra- and inter-cell interference for control and data channels.
- Wi-Fi LTE Integration: Integration at the access network (RAN) level instead of (currently) at the core network level. The operator will be able to gain more control through network centric mobility mechanisms or device centric mechanisms.

With enhancements from Release 12, 4G femtocells deployed for stadiums will no longer have to face the challenging inter-layer interference problems.

Summary and Conclusions

With the growth forecasts for real-time traffic, the current solution of Wi-Fi plus cellular for football stadiums will soon run into trouble. The cellular network will not have enough capacity and Wi-Fi cannot provide sufficient QoS.

It is well-known that smaller cells will produce higher capacity, so multi-mode femtocells seem to be a natural solution. However, to successfully deploy a HetNet solution for hotspots like stadiums one must first solve the challenging inter-layer interference problem.

This white paper has analyzed the potential interference scenarios for football stadiums and proposed four options that can serve as the near-term, intermediate-term and long-term solutions.

The first near-term solution uses fixed frequency partitions. It is the simplest solution of all and is immediately implementable. The drawback is that it requires the outdoor microcells located around the stadium to reduce its channel bandwidth. The goal of this solution is to significantly boost the indoor capacity without causing intolerable inter-layer interference.

The second near-term solution uses Fujitsu proprietary interference control algorithms which yield performance comparable to eICIC and are available much sooner. This solution allows full utilization of channel bandwidth for both outdoor cells and indoor cells.

The proposed intermediate-term solution uses LTE-Advanced features like eICIC to dynamically avoid inter-layer interference. Coordination between the two layers is needed in order to dynamically avoid the interference between the two layers. Dynamic eICIC can handle the unpredictable traffic load variations between indoor (stadiums) and outdoor (the areas around the stadiums such as parking lots and roads).

The long-term solution fundamentally solves the inter-layer interference problem by introducing high-frequency bands for small cells. Additional new features such as inter-band carrier aggregation and advanced receiver technologies will further enhance the capacity and performance of HetNets.

In conclusion, multi-mode 4G femtocells gives the best solution to provide wireless services to hotspots like football stadiums.

References

- [1] William C.Y. Lee, "Smaller Cell for Greater Performance", IEEE Communication Magazine, November 1991, pp. 19–23.
- [2] K. Dimou, "Interference Management within 3GPP LTE Advanced – Part II", Ericsson
- [3] R1-102975, "Downlink CCH Performance Aspects for Macro and HeNB Deployment in Dense Urban Scenario"
- [4] R1-104661, "Comparison of Time-Domain eICIC Solutions"
- [5] R1- 104968, "Summary of the Description of Candidate eICIC Solutions"
- [6] R1-104256, "eICIC Solutions Details"
- [7] TS 36.211, LTE Physical Channels and Modulation, 3GPP
- [8] TS 36.300, Overall description, Section 10.1.3
- [9] D. Kimura, Y. Harada and H. Seki., "De-Centralized Dynamic ICIC using X2 Interfaces for Downlink LTE Systems", Fujitsu Laboratories, Japan
- [10] RWS-120003, Ericsson, Ljubljana RAN Workshop
- [11] RWS-120004, NSN, Ljubljana RAN Workshop
- [12] RWS-120006, Huawei, Ljubljana RAN Workshop
- [13] RWS-12019, Panasonic, Ljubljana RAN Workshop
- [14] RWS-120021, Samsung, Ljubljana RAN Workshop
- [15] RWS-120025, Dan Tong Telecom, Ljubljana RAN Workshop
- [16] RWS-120035, Ljubljana RAN Workshop
- [17] Ericsson white paper on LTE Release 12, January 2013

Acronyms

ABS	Almost Blank Sub-frames
AP	Access Point
BE	Best Effort
BPL	Building Penetration Loss
CCE	Control Channel Element
DL	Downlink
eICIC	Enhanced ICIC
eNB	Evolved Node B
FFR	Fractional Frequency Reuse
HeNB	Home eNB
HetNet	Heterogeneous Network
IC	Interference Control
ICIC	Inter-cell Interference Coordination
LOS	Line-of-Sight
LPN	Low-Power-Nodes (same as small cell)
OFDM	Orthogonal Frequency Division Multiplex
QoS	Quality of Service
RB	Resource Block
SINR	Signal-to-Interference and Noise Ratio
UE	User Equipment
UL	Uplink