

How to identify P/N and Lot Number

Introduction

The purpose of this document aims to provide you with a guideline to the removal of battery & its installation and the identification of the battery's P/N and Lot Number.

The information in this article applies to:

LIFEBOOK Models: C1320 / C1320D / C1321 / C1321D/ P1510 / P1510D / P7120 /
P7120D / Q2010 / S7020 / S7020D / S7021 /S7021D / S7025 /
S7025D / T4210

The affected Battery Pack P/N and Lot Number

The table below lists the part numbers (P/N) and Lot Numbers of the battery packs that are subject to the program. The table covers all affected batteries, but not all batteries within the range of the Lot Numbers may be affected. Further details will be made available on the respective country/regional websites beginning from late October.

| LIFEBOOK Models | Battery P/Ns | Lot Numbers |
|---------------------------------|--------------|-------------|
| C1320 / C1320D / C1321 / C1321D | CP255100-01 | 5624 – 6511 |
| | CP255108-01 | 5628 – 5Y15 |
| P1510 / P1510D | CP229720-01 | 5701 – 6425 |
| | CP229725-01 | 5704 – 6421 |
| P7120 / P7120D | CP234003-01 | 5Y11 – 6424 |
| | CP234019-01 | 5915 – 6426 |
| Q2010 | CP283030-01 | 6403 – 6412 |
| S7020 / S7020D | CP267910-01 | 5919 – 6407 |
| S7021 / S7021D / S7025 /S7025D | CP267915-01 | 5X04 – 6307 |
| T4210 | CP293420-01 | 6508 – 6510 |

Note: Second digit of the Lot Number is one of 1,2,3,4,5,6,7,8,9,X,Y,Z in this order.

Quick steps of how to check if your battery is affected

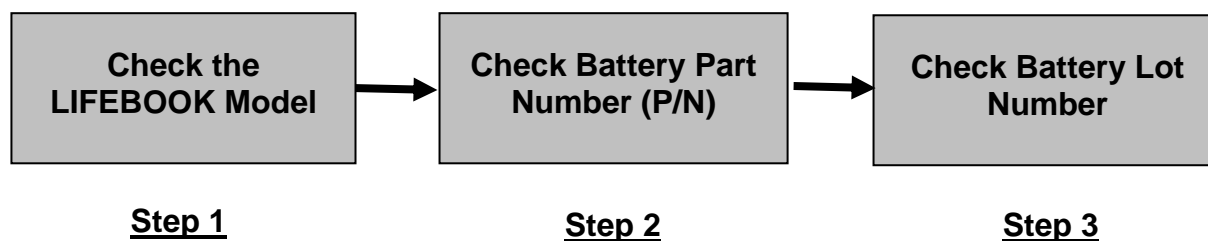

1) LIFEBOOK C1320 / C1320D / C1321 / C1321D

Instruction for Removal of the battery pack

While pressing the latches that lock the battery, push the battery outwards in the direction of the arrow as shown.

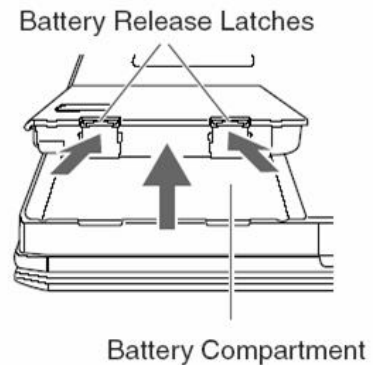

Identification of battery P/N and Lot Number

Upon removal of battery, check the label as shown below.
Confirm the P/N: CP255100-01/ CP255108-01 and Lot Number.

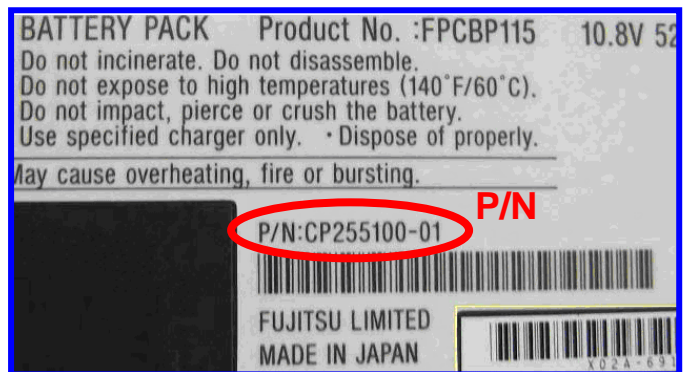

Re-Installation of battery pack post inspection

Once the inspection is completed, press the latches on the battery pack and align it to fit into the battery compartment of the notebook. When the battery falls in place, push the battery inwards as shown and release the latches.

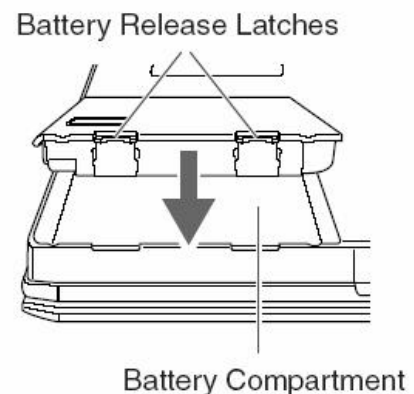

2) LIFEBOOK S7020 / S7020D / S7021 / S7021D / S7025 / S7025D

Instruction for removal of the battery pack

While pressing the latches that lock the battery, push the battery outwards in the direction of the arrow as shown.

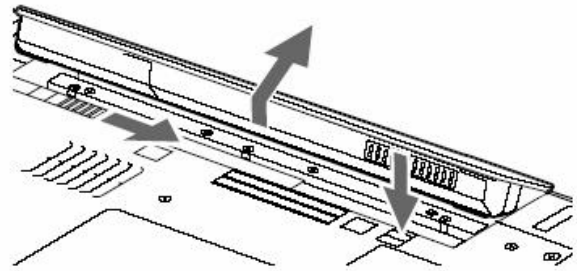

Identification of battery P/N and Lot Number

Upon removal of battery, check the label as shown below. Confirm the P/N: CP267910-01/CP267915-01 and Lot Number.



Re-Installation of the battery pack post inspection

Press the latches on the battery pack and align it to fit into the battery compartment of the notebook. When the battery falls in place, push the battery inwards as shown and release the latches.

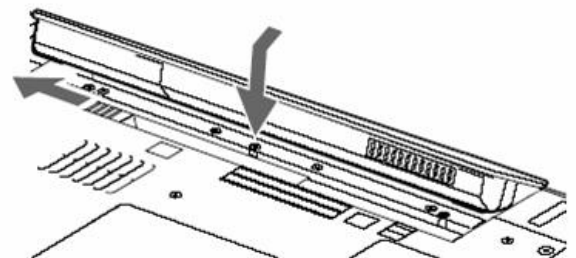

3) LIFEBOOK P1510 / P1510D

Instructions for removal of the battery pack

While pressing the latches that lock the battery, push the battery outwards in the direction of the arrow as shown.

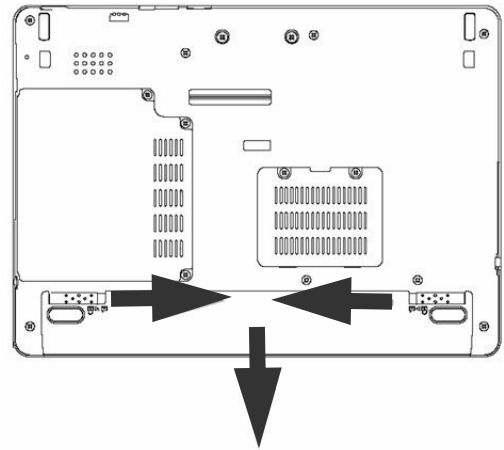

Identification of battery P/N and Lot Number

Upon removal of battery, check the label as shown below. Confirm the P/N: CP229720-01/ CP229725-01 and Lot Number.



P/N

Lot Number

Re-installation of the battery pack post inspection

Firmly insert the battery pack until you hear a "Click" Sound.

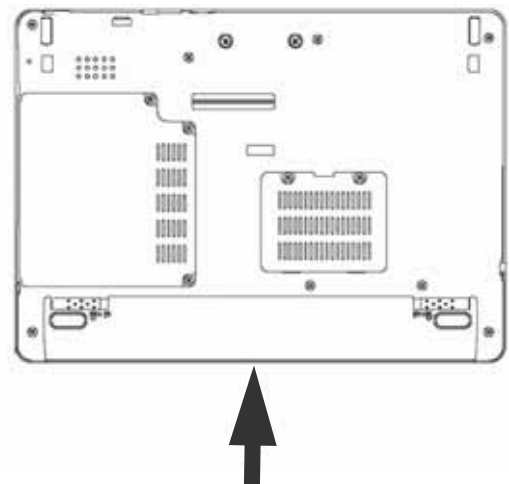

4) LIFEBOOK P7120 / P7120D

Instructions for removal of the battery pack

While pressing the latches that lock the battery, push the battery outwards in the direction of the arrow as shown.

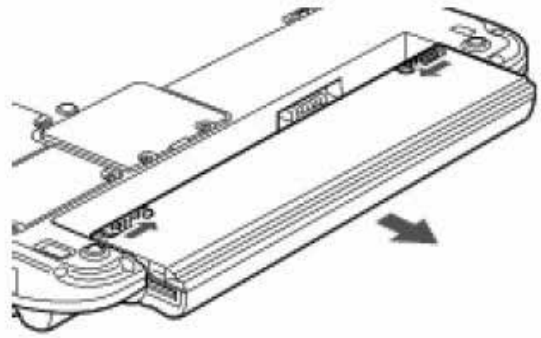

Identification of battery P/N and Lot Number

Upon removal of battery, check the label as shown below. Confirm the P/N: CP234019-01 / CP234003-01 and Lot Number.



P/N

Lot Number

Re-Installation of the battery pack post inspection

Firmly insert the battery pack until you hear a "Click" Sound.

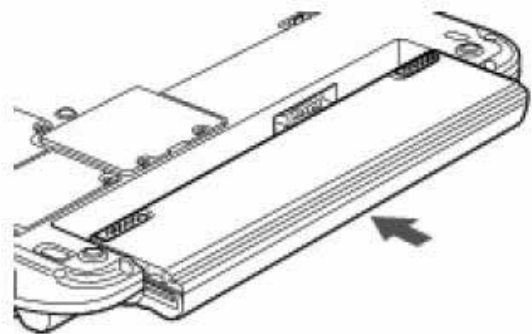

5) LIFEBOOK Q2010

Instructions for removal of the battery pack

While pressing the latches that lock the battery, push the battery outwards in the direction of the arrow as shown.

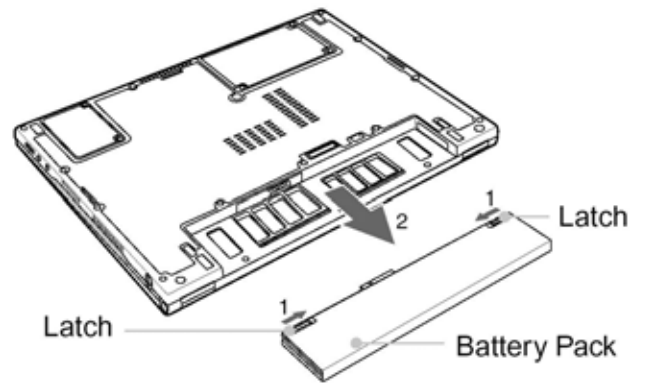

Identification of battery P/N and Lot Number

Upon removal of battery, check the label as shown below. Confirm the P/N: CP283030-01 and Lot Number.



Re-Installation of the battery pack post inspection

Align the battery groove to fit the battery compartment guide. Slide battery inwards in the direction of the arrow as shown. A “click” sound is heard once the battery locks into position.

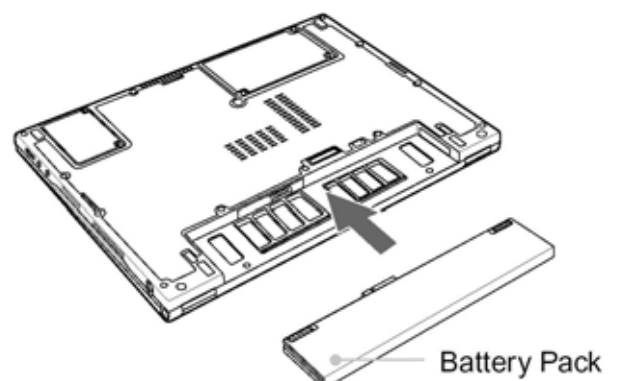

6) LIFEBOOK T4210

Instructions for removal of the battery pack

While pressing the latches that lock the battery, push the battery outwards in the direction of the arrow as shown.

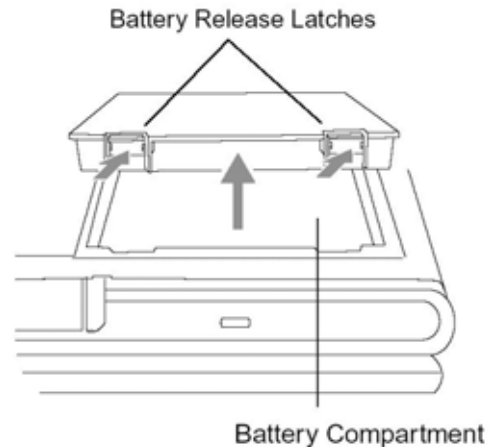

Identification of battery P/N and Lot Number

Upon removal of battery, check the label as shown below. Confirm the P/N: CP293420-01 and Lot Number.

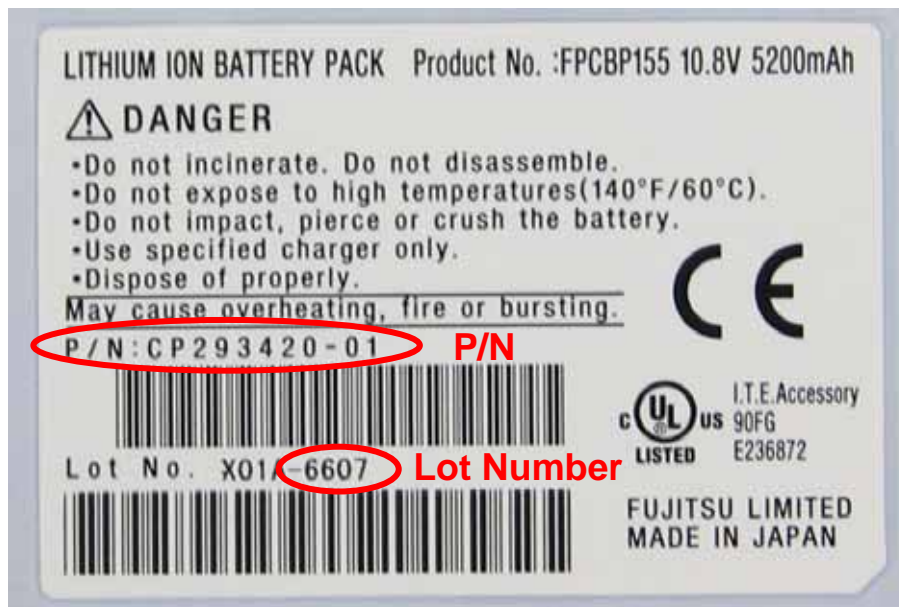

Re-Installation of the battery pack post inspection

Slide the new battery into the compartment, and close the compartment and the battery release latches will click into place.

