

3.3.4 Power supply connector (CN1)

Figure 3.8 shows the pin assignment of the power supply connector (CN1).

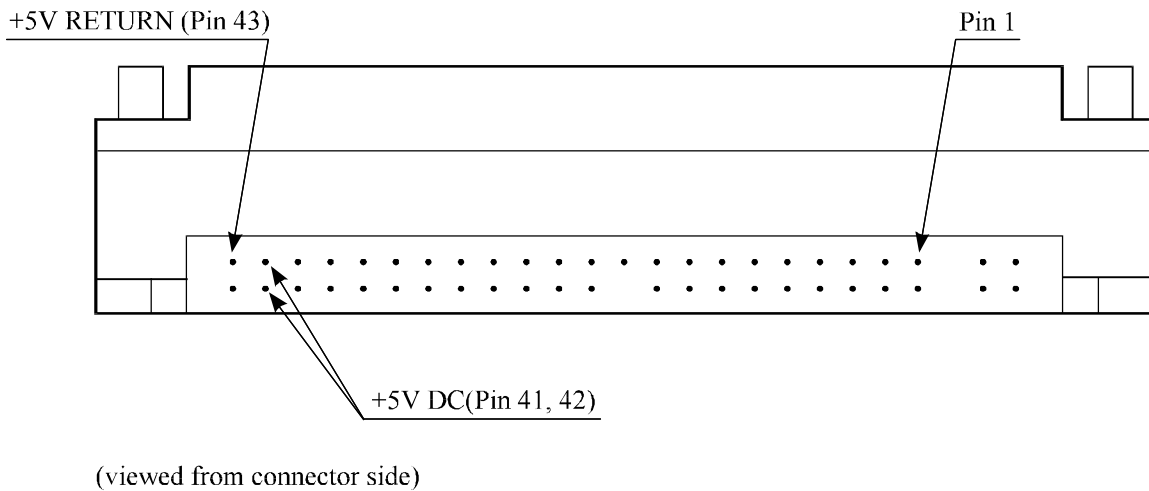

Figure 3.8 Power supply connector pins (CN1)

3.4 Jumper Settings

3.4.1 Location of setting jumpers

Figure 3.9 shows the location of the jumpers to select drive configuration and functions.

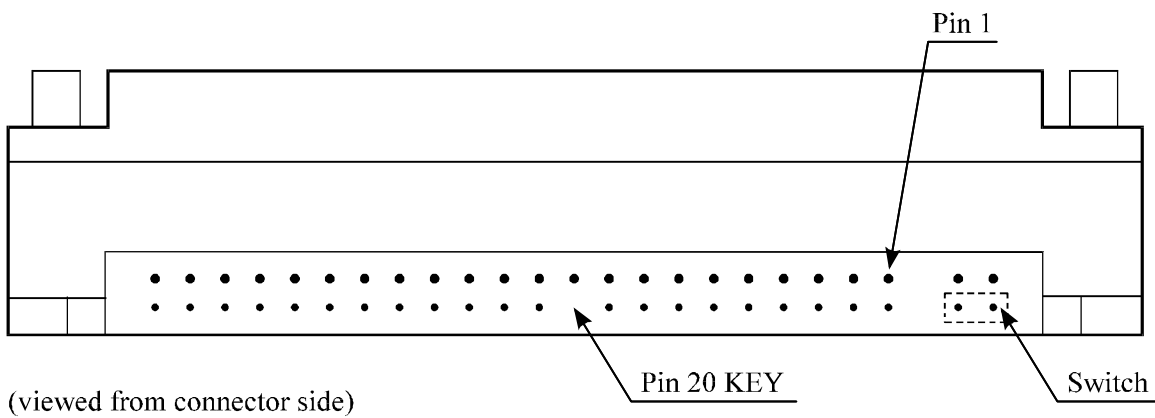

Figure 3.9 Jumper location

3.4.2 Factory default setting

Figure 3.10 shows the default setting position at the factory.

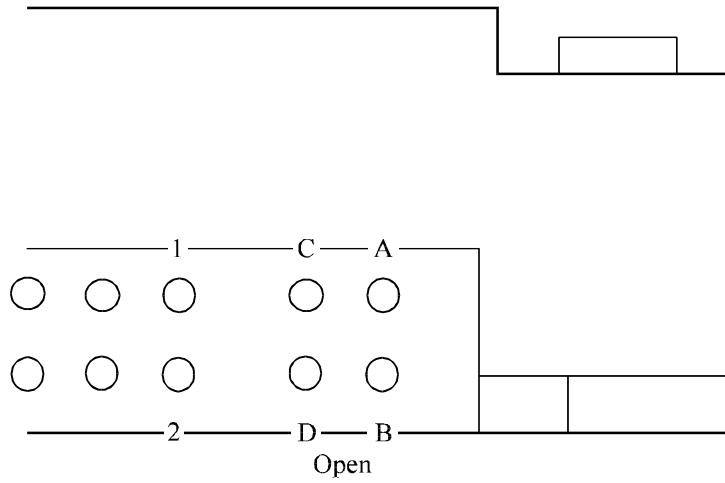

Figure 3.10 Factory default setting

3.4.3 Master drive-slave drive setting

Master device (device #0) or slave device (device #1) is selected.

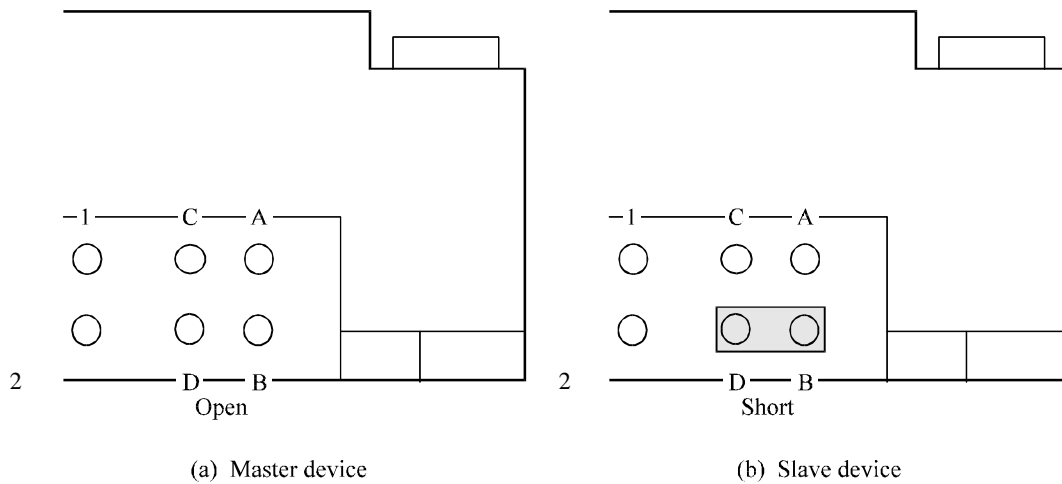

Figure 3.11 Jumper setting of master or slave device

Note:

Pins A and C should be open.

3.4.4 CSEL setting

Figure 3.12 shows the cable select (CSEL) setting.

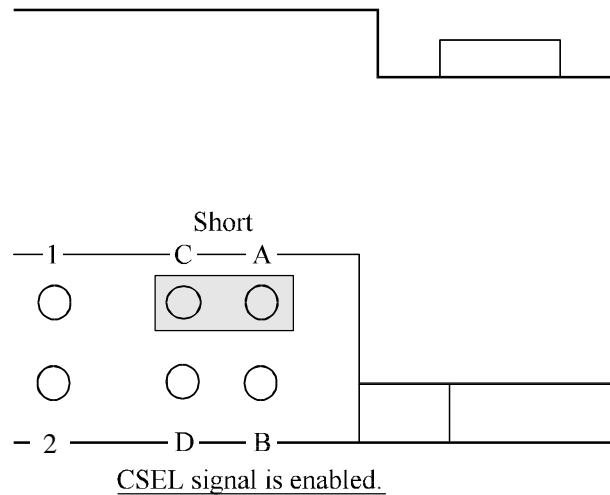

Note:

The CSEL setting is not depended on setting between pins Band D.

Figure 3.12 CSEL setting

Figure 3.13 and 3.14 show examples of cable selection using unique interface cables.

By connecting the CSEL of the master device to the CSEL Line (conductor) of the cable and connecting it to ground further, the CSEL is set to low level. The device is identified as a master device. At this time, the CSEL of the slave device does not have a conductor. Thus, since the slave device is not connected to the CSEL conductor, the CSEL is set to high level. The device is identified as a slave device.

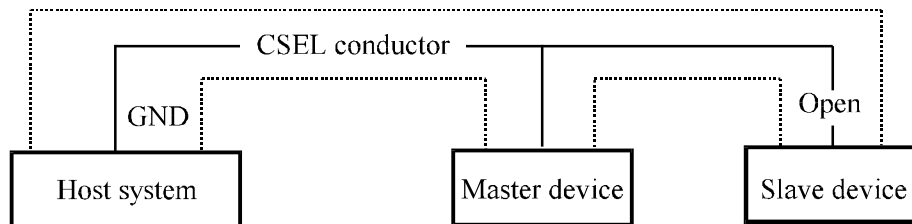

Figure 3.13 Example (1) of Cable Select

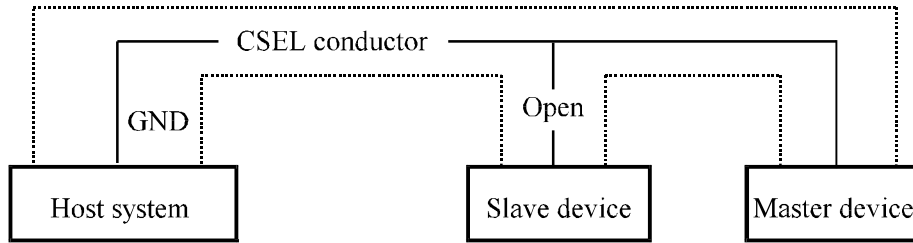

Figure 3.14 Example (2) of Cable Select